

---

# M-Turbo Ultrasound System



*User Guide*

**CE**  
0086



# M-Turbo Ultrasound System

*User Guide*

**Manufacturer**

**FUJIFILM SonoSite, Inc.**

21919 30th Drive SE

Bothell, WA 98021

USA

T: 1-888-482-9449 or 1-425-951-1200

F: 1-425-951-1201

**EC Authorized Representative**

**Emergo Europe**

Molenstraat 15

2513 BH, The Hague

The Netherlands

**Australia Sponsor**

**FUJIFILM SonoSite Australasia Pty Ltd**

114 Old Pittwater Road

BROOKVALE, NSW 2100

Australia

**Caution:** | Federal (United States) law restricts this device to sale by or on the order of a physician.

M-Turbo, SiteLink, SonoCalc, SonoHD, SonoMB, SonoSite, and the SonoSite logo are trademarks or registered trademarks of FUJIFILM SonoSite, Inc. in various jurisdictions.

DICOM is a registered trademark of the National Electrical Manufacturers Association.

All other trademarks are the property of their respective owners.

Patents: US 8,398,408; US 8,355,554; US 8,216,146; US 8,213,467; US 8,164,011; US 8,137,278; US 8,088,071; US 8,066,642; US 7,804,970; US 7,740,586; US 7,686,766; US 7,591,786; US 7,588,541; US 7,534,211; US 7,449,640; US 7,169,108; US 6,962,566; US 6,648,826; US 6,569,101; US 6,471,651; US 6,416,475; US 6,383,139; US 6,371,918; US 6,364,839; US 6,135,961; US 5,893,363; US 5,817,024; US 5,782,769; US 5,722,412; US D538,432; US D509,900; AU 727381; AU 730822; CA 2,371,711; CA 2,372,152; CA 2,373,065; CN 97113678.5; CN 98106133.8; CN 200830007734.8; EP 0875203; EP 0881492; EP 1175713; EP 1180970; EP 1180971; EP 1552792; EP 1589878; JP 4696150; KR 528102; and KR 532359.

P07662-04 06/2014

Copyright© 2014 FUJIFILM SonoSite, Inc. All rights reserved.

# Contents

## Introduction

Conventions, symbols, and terms .....	7
Customer comments .....	7

## Chapter 1: Getting Started

About the system .....	1
Preparing the system .....	1
Installing or removing the battery .....	1
Using AC power and charging the battery .....	2
Turning the system on or off .....	3
Connecting transducers .....	4
Inserting and removing USB storage devices .....	4
System controls .....	5
Screen layout .....	7
General interaction .....	9
Touchpad and cursor .....	9
On-screen options .....	9
Annotation and text .....	9
Preparing transducers .....	11
Training videos .....	12
Intended uses .....	13

## Chapter 2: System Setup

Displaying the setup pages .....	15
Restoring default settings .....	15
A & B Key, Footswitch setup .....	15
Security settings .....	16
User setup .....	16
Exporting or importing user accounts .....	17
Exporting and clearing the Event log .....	17
Logging in as user .....	18
Choosing a secure password .....	18
Annotations setup .....	18
Audio, Battery setup .....	19
Cardiac Calculations setup .....	19
Connectivity setup .....	19
Date and Time setup .....	20
Display Information setup .....	20
IMT Calculations setup .....	20
Network Status setup .....	20

OB Calculations setup .....	20
OB Custom Measurements setup .....	21
OB Custom Tables setup .....	21
Presets setup .....	22
System Information setup .....	23
USB Devices setup .....	23
Limitations of JPEG format .....	23
eFilm Lite image-viewer .....	24

### Chapter 3: Imaging

Imaging modes .....	25
2D imaging .....	25
M Mode imaging .....	30
CPD and color Doppler imaging .....	30
PW and CW Doppler imaging .....	31
Adjusting depth and gain .....	33
Freezing, viewing frames, and zooming .....	33
Imaging modes and exams available by transducer .....	34
Annotating images .....	39
Patient information form .....	40
Images and clips .....	42
Saving images and clips .....	42
Reviewing patient exams .....	43
Printing, exporting, and deleting images and clips .....	44
ECG Monitoring .....	45

### Chapter 4: Measurements and Calculations

Measurements .....	47
Working with calipers .....	47
2D measurements .....	48
M Mode measurements .....	49
Doppler measurements .....	49
General calculations .....	51
Calculations menu .....	51
Performing and saving measurements in calculations .....	51
Displaying, repeating, and deleting saved measurements in calculations .....	52
EMED calculations .....	52
Percent reduction calculations .....	52
Volume calculations .....	54
Volume flow calculations .....	54
Exam-based calculations .....	56
Cardiac calculations .....	56
Measurement publications and terminology (Cardiac) .....	65
Gynecology (Gyn) calculations .....	66

IMT calculations .....	67
OB calculations .....	69
Small Parts calculations .....	72
Transcranial Doppler and Orbital calculations .....	73
Vascular calculations .....	75
Patient report .....	77
Vascular and cardiac patient reports .....	77
TCD patient report .....	78
OB patient report .....	78
EMED worksheets .....	78
MSK worksheets .....	79

## Chapter 5: Troubleshooting and Maintenance

Troubleshooting .....	81
Maintenance .....	82
Cleaning and disinfecting the ultrasound system .....	83
Cleaning and disinfecting transducers .....	84
Cleaning and disinfecting the battery .....	86
Cleaning the footswitch .....	86
Cleaning and disinfecting ECG cables .....	86
Recommended disinfectants .....	87

## Chapter 6: Safety

Ergonomic safety .....	95
Position the system .....	96
Position yourself .....	96
Take breaks, exercise, and vary activities .....	97
Electrical safety classification .....	97
Electrical safety .....	98
Equipment safety .....	100
Battery safety .....	101
Clinical safety .....	102
Hazardous materials .....	103
Electromagnetic compatibility .....	104
Separation distance .....	106
Compatible accessories and peripherals .....	106
Guidance and manufacturer's declaration .....	108
Applying ALARA .....	114
Direct controls .....	114
Indirect controls .....	114
Receiver controls .....	115
Acoustic artifacts .....	115
Guidelines for reducing MI and TI .....	115
Output display .....	118
MI and TI output display accuracy .....	119
Factors that contribute to display uncertainty .....	119

Related guidance documents .....	120
Transducer surface temperature rise .....	120
Acoustic output measurement .....	121
<i>In Situ</i> , derated, and water value intensities .....	121
Tissue models and equipment survey .....	122
Acoustic output tables .....	123
Terms used in the acoustic output tables .....	164
Acoustic measurement precision and uncertainty .....	165
Labeling symbols .....	166

## Chapter 7: References

Measurement accuracy .....	171
Sources of measurement errors .....	172
Measurement publications and terminology .....	173
Cardiac references .....	173
Obstetrical references .....	177
Gestational age tables .....	178
Growth analysis tables .....	180
Ratio calculations .....	181
General references .....	182

## Chapter 8: Specifications

Dimensions .....	185
System .....	185
Display .....	185
Supported transducers .....	185
Imaging modes .....	185
Image and clip storage .....	185
Accessories .....	185
Peripherals .....	186
Operating .....	186
Shipping and storage .....	186
Electrical .....	186
Battery .....	186
Standards .....	186
Electromechanical safety standards .....	186
Acoustic standards .....	187
Biocompatibility standards .....	187
Airborne equipment standards .....	187
DICOM standard .....	187
HIPAA standard 45 CFR 160, General Administrative Requirements. ....	187

## Glossary

Terms .....	189
Abbreviations .....	191







# Introduction

This *M-Turbo Ultrasound System User Guide* provides information on preparing and using the M-Turbo ultrasound system and on cleaning and disinfecting the system and transducers. It also provides references for calculations, system specifications, and safety and acoustic output information.

The user guide is for a reader familiar with ultrasound techniques. It does not provide training in sonography or clinical practices. Before using the system, you must have ultrasound training.

See the applicable SonoSite accessory user guide for information on using accessories and peripherals. See the manufacturer's instructions for specific information about peripherals.

## Conventions, symbols, and terms

The user guide follows these conventions:

- A **WARNING** describes precautions necessary to prevent injury or loss of life.
- A **Caution** describes precautions necessary to protect the products.
- Numbered steps in procedures must be performed in order.
- Items in bulleted lists do not require a sequence.
- Single-step procedures begin with ❖.

Symbols and terms used on the system and transducer are explained in [Chapter 1](#), [Chapter 5](#), [Chapter 6](#), and [Glossary](#).

## Customer comments

Questions and comments are encouraged. SonoSite is interested in your feedback regarding the system and the user guide. Please call SonoSite at 888-482-9449 in the US. Outside the US, call the nearest SonoSite representative. You can also e-mail SonoSite at [comments@sonosite.com](mailto:comments@sonosite.com).

For technical support, please contact SonoSite as follows:

### SonoSite Technical Support

Phone (US or Canada):	877-657-8118
Phone (Outside US and Canada):	425-951-1330 Or call your local representative.
Fax:	425-951-6700
E-mail:	<a href="mailto:service@sonosite.com">service@sonosite.com</a>
Web site:	<a href="http://www.sonosite.com">www.sonosite.com</a>
Europe Service Center:	+44-(0)1462-341-151 <a href="mailto:uk-service@sonosite.com">uk-service@sonosite.com</a>



# Chapter 1: Getting Started

## About the system

The M-Turbo ultrasound system is a portable, software-controlled device using all-digital architecture. The system has multiple configurations and feature sets used to acquire and display high-resolution, real-time ultrasound images. Features available on your system depend on system configuration, transducer, and exam type.

A license key is required to activate the software. See “A maintenance icon appears on the system screen. Restart the system. If the issue recurs, system maintenance may be required. Note the number that appears in parentheses on the C: line and contact SonoSite or your SonoSite representative. Software licensing” on page 82. On occasion, a software upgrade may be required. SonoSite provides a USB device containing the software. One USB device can be used to upgrade multiple systems.

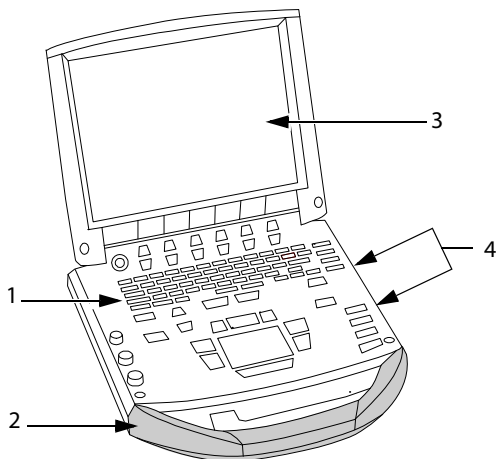

Figure 1 System Front Features:  
(1) Control panel, (2) Handle, (3) Display, (4) USB ports for storage, updates, importing, and exporting

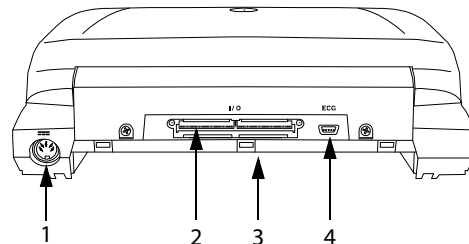

Figure 2 System Back Connectors:  
(1) DC input connector, (2) I/O connector, (3) Battery, and (4) ECG connector

### To use the ultrasound system

- 1 Attach a transducer.
- 2 Turn the system on. (For power switch location, see “System controls” on page 5.)
- 3 Press the PATIENT key, and complete the patient information form.
- 4 Press an imaging mode key: 2D, M MODE, COLOR, or DOPPLER

## Preparing the system

### Installing or removing the battery

**WARNING:** To avoid injury to the operator and to prevent damage to the ultrasound system, inspect the battery for leaks prior to installing.

To avoid data loss and to conduct a safe system shutdown, always keep a battery in the system.

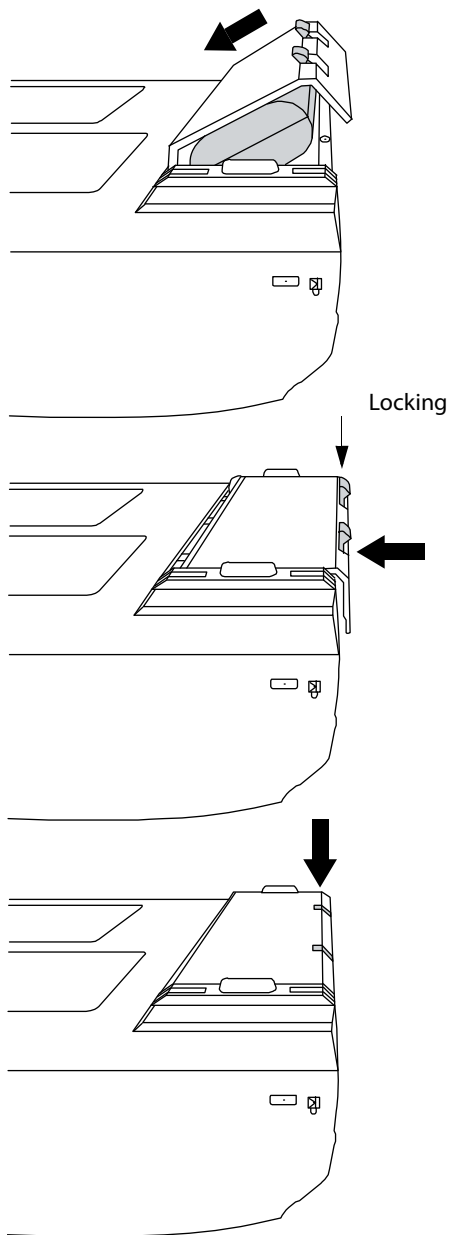

Figure 3 Install the Battery

### To install the battery

- 1 Disconnect the power supply from the ultrasound system.
- 2 Remove the system from the mini-dock (if present) and turn it upside down.
- 3 Place the battery into the battery compartment, at a slight angle. See [Figure 3](#).
- 4 Slide the battery forward until it locks into place.
- 5 Push down on the two locking levers to secure the battery.

### To remove the battery

- 1 Disconnect the power supply from the ultrasound system.
- 2 Remove the system from the mini-dock (if present) and turn it upside down.
- 3 Pull up the two locking levers.
- 4 Slide the battery back.
- 5 Lift the battery from the compartment.

### Using AC power and charging the battery

The battery charges when the system is connected to the AC power supply. A fully discharged battery recharges in less than five hours.

When using AC power, position the system to allow easy access to disconnect it.

### To separate the system (and any connected equipment) from a supply mains

*Note: Disconnecting only the DC power cable from the system or dock does not separate the system from the supply mains.*

- ❖ Disconnect the AC power cord from the power supply or (alternatively, if using a stand) from the AC adapter on the stand base.

The system can run on AC power and charge the battery if AC power is connected to the system directly, to a mini-dock, or to a docking system.

The system can run on battery power for up to two hours, depending on the imaging mode and the display brightness. When running on battery power, the system may not restart if the battery is low. To continue, connect the system to AC power.

**WARNING:** The equipment shall be connected to a center-tapped single phase supply circuit when users in the United States connect the equipment to a 240V supply system.

**Caution:** Verify that the hospital supply voltage corresponds to the power supply voltage range. See [“Electrical”](#) on page 186.

### To operate the system using AC power

- 1 Connect the DC power cable from the power supply to the connector on the system. See [Figure 2](#) on page 1.
- 2 Connect the AC power cord to the power supply and to a hospital-grade electrical outlet.

### Turning the system on or off

**Caution:** Do not use the system if an error message appears on the display. Note the error code and turn off the system. Call SonoSite or your local representative.

### To turn the system on or off

- ❖ Press the power switch. (See [“System controls”](#) on page 5.)

### To wake up the system

To conserve battery life while the system is on, the system goes into sleep mode if the lid is closed or if the system is untouched for a preset time. To adjust the time for sleep delay, see [“Audio, Battery setup”](#) on page 19.

- ❖ Press a key, touch the touchpad, or open the lid.

## Connecting transducers

**WARNING:** To avoid injury to the patient, do not place the connector on the patient. Operate the ultrasound system in a docking system or on a flat hard surface to allow air flow past the connector.

**Caution:** To avoid damaging the transducer connector, do not allow foreign material in the connector.

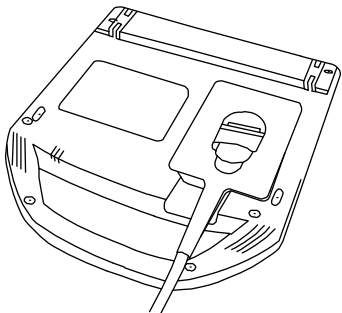
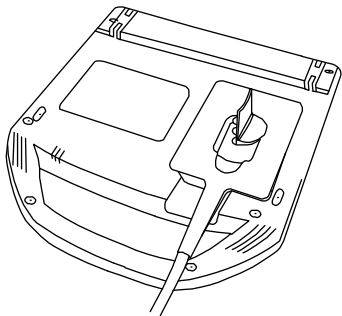
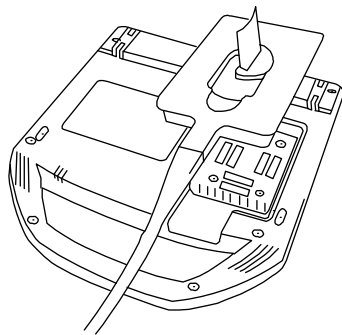

Figure 4 Connect the Transducer

## To connect a transducer

- 1 Remove the system from the mini-dock (if present), and turn it upside down.
- 2 Pull the transducer latch up, and rotate it clockwise.
- 3 Align the transducer connector with the connector on the bottom of the system.
- 4 Insert the transducer connector into the system connector.
- 5 Turn the latch counterclockwise.
- 6 Press the latch down, securing the transducer connector to the system.

## To remove a transducer

- 1 Pull the transducer latch up, and rotate it clockwise.
- 2 Pull the transducer connector away from the system.

## Inserting and removing USB storage devices

Images and clips are saved to internal storage and are organized in a sortable patient list. You can archive the images and clips from the ultrasound system to a PC using a USB storage device or Ethernet connection. Although the images and clips cannot be viewed from a USB storage device on the ultrasound system, you can remove the device and view them on your PC.

There are two USB ports on the system, and one on the mini-dock. For additional USB ports, you can connect a USB hub into any USB port.

*Note: The system does not support password-protected USB storage devices. Make sure that the USB storage device you use does not have password protection enabled.*



# System controls

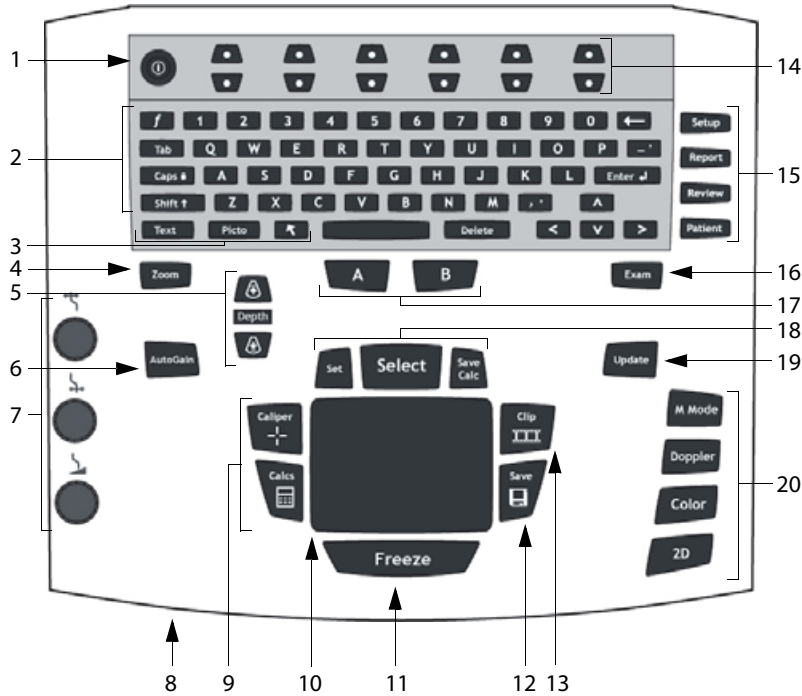

1	Power switch	Turns system on and off.
2	Alphanumeric keys	Use to enter text and numbers.
3	Annotation keys	See <i>"Alphanumeric keyboard"</i> on page 9.
4	ZOOM	Magnifies the image 100%.
5	DEPTH UP, DEPTH DOWN	Decreases and increases imaging depth.
6	AUTO GAIN	Adjusts gain automatically.
7	<b>Gain</b>	
	Near	Adjusts the gain applied to the near field of the image.
	Far/ Angle Correction	In live imaging, adjusts the gain applied to the far field of the image. On a frozen PW Doppler image, adjusts the angle.
	Gain/ Cine Buffer	In live imaging, adjusts the overall gain applied to the entire image. On a frozen image, moves the cine buffer.

8	AC power indicator	A steady light indicates that AC power is connected. A flashing light indicates that the system is asleep.
9	CALIPER CALCS	Displays calipers on-screen for measuring. Turns the calculations menu on and off.
10	Touchpad	Selects, adjusts, and moves items on-screen.
11	FREEZE	Stops live imaging and displays a frozen image.
12	SAVE	Saves an image to internal storage. If configured, also saves calculations to the report. See “Presets setup” on page 22.
13	CLIP	Saves a clip to internal storage.
14	Control keys	Control on-screen options.
15	<b>Forms</b>	
	SETUP	Displays the system settings.
	REPORT	Accesses the patient report and EMED worksheets.
	REVIEW	Accesses the patient list, saved images, and archiving functions.
	PATIENT	Accesses patient information.
16	EXAM	Opens exam menu.
17	A & B shortcut keys	Keys that you can program to perform common tasks.
18	SET	Sets a trace measurement.
	SELECT	Used with the touchpad to select items on-screen. Also switches between Color and Doppler options, calipers for measurement, pictograph-marker position and angle, frozen images in duplex and dual screens, and arrow position and orientation.
	SAVE CALC	Saves calculations and their measurements to the patient report.
19	UPDATE	Toggles between dual and duplex screens and imaging modes in M Mode and Doppler (for example, between D-line and Doppler spectral trace).
20	<b>Imaging Modes</b>	
	M MODE	Turns M Mode on, toggles between M-line and M Mode trace.
	DOPPLER	Turns Doppler on, toggles between D-line and Doppler trace.
	COLOR	Turns CPD/Color on and off.
	2D	Turns 2D on.

# Screen layout

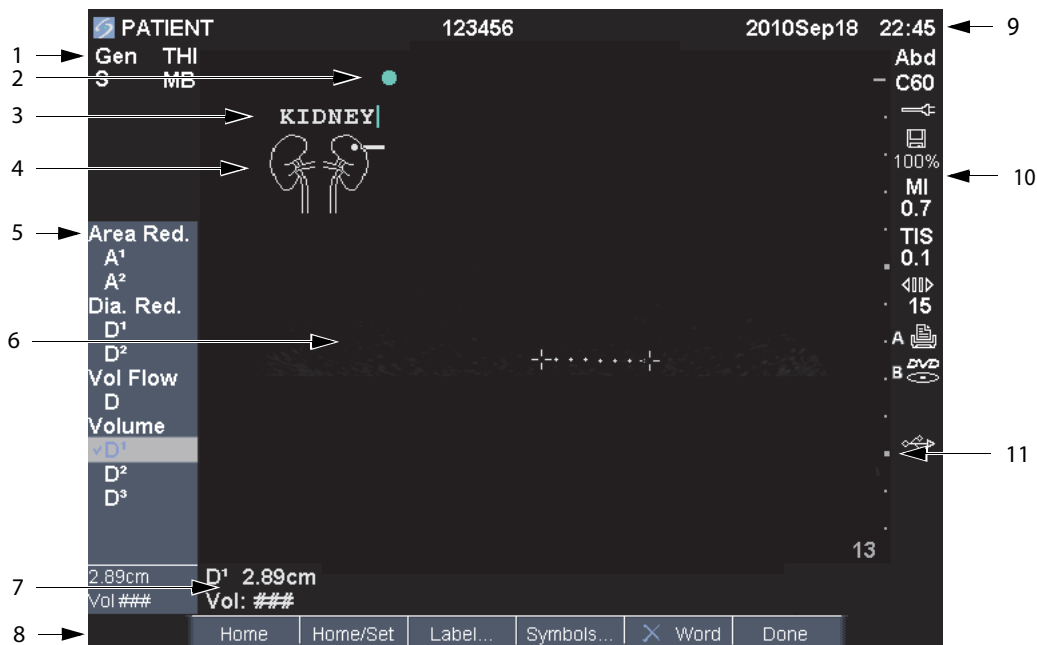

Figure 1 Screen Layout

1	Mode Data Area	Current imaging mode information (for example, Gen, Res, THI, and PW).
2	Orientation Marker	Provides indication for image orientation. In dual and duplex images, the orientation marker is green on the active screen.
3	Text	Text entered using keyboard.
4	Pictograph	Pictograph to indicate anatomy and transducer position. You can select anatomy and screen location.
5	Calculations Menu	Contains available measurements.
6	Image	Ultrasound image.
7	Measurement and Calculations Data Area	Current data on measurements and calculations.
8	On-screen Options	Options available in the current context.
9	Patient Header	Includes current patient name, ID number, institution, user, and date/time.
10	System Status	Information on system status (for example, exam type, transducer, AC connected, battery charging, and USB).
11	Depth Marker	Marks in .5 cm, 1 cm, and 5 cm increments depending on depth.

- WARNING:** To avoid damaging the USB storage device and losing patient data from it, observe the following:
- Do not remove the USB storage device or turn off the ultrasound system while the system is exporting.
  - Do not bump or otherwise apply pressure to the USB storage device while it is in a USB port on the ultrasound system. The connector could break.

**Caution:** If the USB icon does not appear in the system status area on-screen, the USB storage device may be defective or password-protected. Turn the system off and replace the device.

### To insert a USB storage device

- ❖ Insert the USB storage device into any USB port on the system or mini-dock. See [Figure 1](#) on page 1.

The USB storage device is ready when the USB icon appears.

To view information about the device, see [“USB Devices setup”](#) on page 23.

### To remove a USB storage device

Removing the USB storage device while the system is exporting to it may cause the exported files to be corrupted or incomplete.

- 1 Wait five seconds after the USB animation stops.
- 2 Remove the USB storage device from the port.

## Annotation and text

### Alphanumeric keyboard

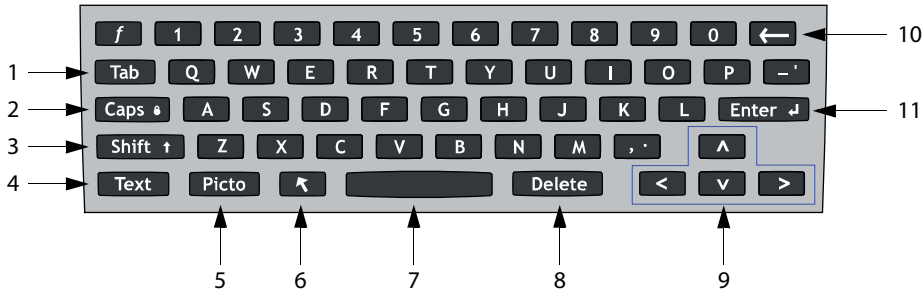

## General interaction

### Touchpad and cursor

Use the touchpad to adjust and move objects on-screen. The touchpad controls caliper position, CPD or Color box position and size, the cursor, and more. The arrow keys control much of the same functionality as the touchpad.

Make sure to keep the touchpad dry while in use. Moisture on the touchpad can cause the cursor to respond erratically.

The cursor appears in the setup pages, the patient information form, and patient report. You control the cursor through the touchpad. For example, in the patient information form, place the cursor over the last name field and press the SELECT key to activate that field. Additionally, you can use the cursor to select check boxes and items in lists.

### On-screen options

The on-screen options let you make adjustments and select settings. The options available depend on context.

Each option is controlled by the pair of keys below it. Depending on the option, the control keys function in one of four ways:

**Cycle** Moves through a list of settings continuously. The upper control key cycles upward. The lower control key cycles downward.

**Up-Down** Moves through a list of settings, stopping at the top or bottom. The upper control key moves upward. The lower control key moves downward. By default, a beep sounds when you reach either end of the range. (See [“Audio, Battery setup”](#) on page 19.)

**On-Off** Turns a feature on or off. You can press either control key. In forms, you can instead select the option by using the touchpad and the SELECT key.

**Action** Performs an action. You can press either control key. Or you can instead select the option by using the touchpad and the SELECT key.



Figure 5 On-screen options (2D imaging shown)

1	TAB	Moves cursor among fields in the forms, and tabs between text position in dual screens.
2	CAPS LOCK	Sets the keyboard to capital letters.
3	SHIFT	Allows entry of capitalized characters and international characters.
4	TEXT	Turns the keyboard on and off for text entry.
5	PICTO	Turns pictographs on and off.
6	ARROW	Displays an arrow graphic that can be moved and rotated within the image area.
7	SPACEBAR	Turns the keyboard on for text entry. In text entry, adds a space.

8	DELETE	Removes all text from the screen during text entry and when not measuring.
9	Arrow Keys	Move highlighted selection in calculations menu, move cursor one space when entering text, move caliper position, move cine buffer forward and backward, and move among pages in image review and reports.
10	BACKSPACE	Removes the character left of the cursor in text-entry mode.
11	ENTER	Moves cursor among fields in forms and saves calculations to report.

## Symbols

You can enter symbols and special characters in select fields and forms. The symbols and special characters available depend on context.

**Patient information form:** Last, First, Middle, Patient ID, Accession, Indications, Procedure ID, User, Reading Dr., Referring Dr., and Institution fields

**DICOM or SiteLink configuration page:** Alias and AE Title fields

**A & B Key, Footswitch setup page:** Text field

**Text mode (imaging):** Annotation field



Figure 6 Symbols Dialog Box

### To enter symbols or special characters

- 1 Select the field, and then select **Symbols**.
- 2 Select the desired symbol or character.  
You can also press the keys on the keyboard.
- 3 Select **OK**.

## Preparing transducers

**WARNING:** Some transducer sheaths contain natural rubber latex and talc, which can cause allergic reactions in some individuals. Refer to 21 CFR 801.437, User labeling for devices that contain natural rubber.

Some gels and sterilants can cause an allergic reaction on some individuals.

**Caution:** To avoid damage to the transducer, use only gels recommended by SonoSite. Using gels other than the one recommended by SonoSite can damage the transducer and void the warranty. If you have questions about gel compatibility, contact SonoSite or your local representative.

SonoSite recommends that you clean transducers after each use. See [“Cleaning and disinfecting transducers”](#) on page 84.

Acoustic coupling gel must be used during exams. Although most gels provide suitable acoustic coupling, some gels are incompatible with some transducer materials. SonoSite recommends Aquasonic® gel and provides a sample with the system.

For general use, apply a liberal amount of gel between the transducer and the body. For invasive or surgical use, be sure to follow the sterilization instructions described in [“Cleaning and disinfecting transducers”](#) on page 84.

**WARNING:** To prevent contamination, the use of sterile transducer sheaths and sterile coupling gel is recommended for clinical applications of an invasive or surgical nature. Do not apply the transducer sheath and gel until you are ready to perform the procedure.

### To apply a transducer sheath

SonoSite recommends the use of market-cleared, transducer sheaths for intracavitary or surgical applications. To lessen the risk of contamination, apply the sheath only when you are ready to perform the procedure.

- 1 Place gel inside the sheath.
- 2 Insert the transducer into the sheath.
- 3 Pull the sheath over the transducer and cable until the sheath is fully extended.
- 4 Secure the sheath using the bands supplied with the sheath.
- 5 Check for and eliminate bubbles between the face of the transducer and the sheath.

Bubbles between the face of the transducer and the sheath may affect the ultrasound image.

**WARNING:** Inspect the sheath to ensure that there are no holes or tears.

## Training videos

The SonoSite® Education Key™ training videos are an optional feature.

### To display the list of videos

- 1 Insert the Education Key USB device into a USB port on the system.
- 2 Press the REVIEW key.

- 3 If there is an active exam, select **List** on-screen.
- 4 Select the **Videos** tab.
- 5 If the list does not appear, select the correct USB device:
  - a Select **Select USB**.
  - b In the **Select USB device for media playback dialog box**, select the Education Key USB device (“Training” appears under **Type**), and then select **Select**.

*Note: Image Gallery is an unsupported feature.*

### To view a video

- 1 Display the list of videos.
- 2 Select the video.
- 3 Select **View** on-screen.  
The video begins playing.
- 4 Select any of the following, as needed:
  -  Adjusts the volume. The higher the number, the louder the sound. Zero is mute.
  - **Back** Rewinds the video 10 seconds.
  - **Pause** Pauses the video.
  - **Play** Resumes playing of a paused video.
  - **Forward** Advances the video 10 seconds.

### To exit a video

- ❖ Select one of the following:
  - **List** to return to the video list.
  - **Done** to return to 2D imaging.



## Intended uses

This system transmits ultrasound energy into various parts of the patient's body to obtain ultrasound images, as follows.

For the intended transducer and imaging modes for each exam type, see [“Imaging modes and exams available by transducer”](#) on page 34.

**Abdominal Imaging Applications** You can assess the liver, kidneys, pancreas, spleen, gallbladder, bile ducts, transplanted organs, abdominal vessels, and surrounding anatomical structures for the presence or absence of pathology transabdominally.

**Cardiac Imaging Applications** You can assess the heart, cardiac valves, great vessels, surrounding anatomical structures, overall cardiac performance, and heart size for the presence or absence of pathology.

In addition, you can identify the presence and location of fluid around the heart and lungs, use to assist in pericardiocentesis and thoracentesis procedures, visualize blood flow through cardiac valves, and detect normal lung motion for the presence or absence of pathology.

You can obtain the patient's electrocardiogram (ECG). The ECG is used for timing of cardiac events.

**WARNING:** The ECG is not used to diagnose cardiac arrhythmias and is not designed for long term cardiac rhythm monitoring.

### **Gynecology and Infertility Imaging Applications**

You can assess the uterus, ovaries, adnexa, and surrounding anatomical structures for the presence or absence of pathology transabdominally or transvaginally.

**Interventional Imaging Applications** You can use the system for ultrasound guidance in biopsy and drainage procedures, vascular line placement, peripheral nerve blocks, spinal nerve blocks and

taps, ova harvesting, amniocentesis and other obstetrical procedures, and provide assistance during abdominal, breast, and neurological surgery.

**Obstetrical Imaging Applications** You can assess the fetal anatomy, viability, estimated fetal weight, gestational age, amniotic fluid, and surrounding anatomical structures for the presence or absence of pathology transabdominally or transvaginally. CPD and Color imaging are intended for high-risk pregnant women. High-risk pregnancy indications include, but are not limited to, multiple pregnancy, fetal hydrops, placental abnormalities, as well as maternal hypertension, diabetes, and lupus.

**WARNING:** To prevent injury or misdiagnosis, do not use this system for Percutaneous Umbilical Blood Sampling (PUBS) or *in vitro* Fertilization (IVF). The system has not been validated to be proven effective for these two uses.

CPD or Color images can be used as an adjunctive method, not as a screening tool, for the detection of structural anomalies of the fetal heart and as an adjunctive method, not as a screening tool for the diagnosis of Intrauterine Growth Retardation (IUGR).

### **Pediatric and Neonatal Imaging Applications**

You can assess the pediatric and neonatal abdominal, pelvic and cardiac anatomy, pediatric hips, neonatal head, and surrounding anatomical structures for the presence or absence of pathology.

**Superficial Imaging Applications** You can assess the breast, thyroid, testicle, lymph nodes, hernias, musculoskeletal structures, soft tissue structures, ophthalmic structures, and surrounding anatomical structures for the

presence or absence of pathology. You can use the system for ultrasound guidance in biopsy and drainage procedures, vascular line placement, peripheral nerve blocks, and spinal nerve blocks and taps.

**WARNING:** To avoid injury to the patient, use only an Orbital (Orb) or Ophthalmic (Oph) exam type when performing imaging through the eye. The FDA has established lower acoustic energy limits for ophthalmic use. The system will not exceed these limits only if the Orb or Oph exam type is selected.

**Transcranial Imaging Applications** You can assess the anatomical structures and vascular anatomy of the brain for presence or absence of pathology. You can use imaging temporally, trans-occipitally, or trans-orbitally.

**WARNING:** To avoid injury to the patient, use only an Orbital (Orb) or Ophthalmic (Oph) exam type when performing imaging through the eye. The FDA has established lower acoustic energy limits for ophthalmic use. The system will not exceed these limits only if the Orb or Oph exam type is selected.

**Vascular Imaging Applications** You can assess the carotid arteries, deep veins, and arteries in the arms and legs, superficial veins in the arms and legs, great vessels in the abdomen, and various small vessels feeding organs for the presence or absence of pathology.

# Chapter 2: System Setup

The system setup pages let you customize the system and set preferences.

## Displaying the setup pages

### To display a setup page

- 1 Press the **SETUP** key.
- 2 Select the setup page under **Setup Pages**.

To return to imaging from a setup page, select **Done** on-screen.

## Restoring default settings

### To restore default settings for a setup page

- ❖ On the setup page, select **Reset** on-screen.

### To restore all default settings

- 1 Turn the system off.
- 2 Connect the system to AC power. (See [“To operate the system using AC power”](#) on page 3.)
- 3 Simultaneously press **1** and the power key.  
The system beeps several times.

## A & B Key, Footswitch setup

On the A & B Key, Footswitch setup page, you can program the shortcut keys and footswitch to perform common tasks. Select from the following lists:

**A Key, B Key** The function of the shortcut keys. By default, the A shortcut key is set to **Print** and the B shortcut key is set to **Record**. The shortcut keys are below the alphanumeric keypad.

**Footswitch (L), Footswitch (R)** The function of the left and right footswitches: **Save Clip, Record, Freeze, Save Image, or Print**. See also [“To connect the footswitch.”](#)

### To connect the footswitch

The SonoSite footswitch allows hands-free operation with a customizable two-pedal footswitch. The footswitch is an optional feature.

**WARNING:** To avoid contamination, do not use the footswitch in a sterile environment. The footswitch is not sterilized.

- 1 Connect the footswitch USB cable to the USB port on the system or mini-dock.
- 2 On the A & B Key, Footswitch setup page, select a function for the left and right footswitches. Administration setup

On the Administration setup page, you can configure the system to require users to log in and enter passwords. Required login helps protect patient data. You can also add and delete users, change passwords, import and export user accounts, and view the event log.

## Security settings

**WARNING:** Health care providers who maintain or transmit health information are required by the Health Insurance Portability and Accountability Act (HIPAA) of 1996 and the European Union Data Protection Directive (95/46/EC) to implement appropriate procedures: to ensure the integrity and confidentiality of information; to protect against any reasonably anticipated threats or hazards to the security or integrity of the information or unauthorized uses or disclosures of the information.

Security settings on the system allow you to meet the applicable security requirements listed in the HIPAA standard. Users are ultimately responsible for ensuring the security and protection of all electronic protected health information collected, stored, reviewed, and transmitted on the system.

### To log in as Administrator

- 1 On the Administration setup page, type **Administrator** in the **Name** box.
- 2 Type the administrator password in the **Password** box.

If you don't have the administrator password, contact SonoSite. (See ["SonoSite Technical Support"](#) on page 7.)

- 3 Select **Login**.

### To log out as Administrator

- ❖ Turn off or restart the system.

### To require user login

You can set the system to display the User Login screen at startup.

- 1 Log in as Administrator.

- 2 In the **User Login** list, select **On**.
  - **On** requires a user name and password at startup.
  - **Off** allows access to the system without a user name and password.

### To change the administrator password or let users change passwords

- 1 Log in as Administrator.
- 2 Under **User List**, select **Administrator**.
- 3 Do any of the following:
  - Change the administrator password: Under **User Information**, type the new password in the **Password** box and **Confirm** box. (See ["Choosing a secure password"](#) on page 18.)
  - Let users change their passwords: Select the **Password changes** check box.
- 4 Select **Save**.

## User setup

### To add a new user

- 1 Log in as Administrator.
- 2 Select **New**.
- 3 Under **User Information**, fill in the **Name**, **Password**, and **Confirm** boxes. (See ["Choosing a secure password"](#) on page 18.)
- 4 (Optional) In the **User** box, type the user's initials to display them in the patient header and the **User** field in the patient information form.
- 5 (Optional) Select the **Administration Access** check box to allow access to all administration privileges.
- 6 Select **Save**.

### To modify user information

- 1 Log in as Administrator.

- 2 Under **User List**, select the user.
- 3 Under **User Information**, make changes as desired.
- 4 Select **Save**.

Any change to the user name replaces the previous name.

### To delete a user

- 1 Log in as Administrator.
- 2 Under **User List**, select the user.
- 3 Select **Delete**.
- 4 Select **Yes**.

### To change a user password

- 1 Log in as Administrator.
- 2 In the **User List**, select the user.
- 3 Type the new password in the **Password** box and **Confirm** box.
- 4 Select **Save**.

## Exporting or importing user accounts

The export and import commands let you configure multiple systems and back up user account information.

### To export user accounts

- 1 Insert a USB storage device.
- 2 Log in as Administrator.
- 3 Select **Export** on-screen. A list of USB devices appears.
- 4 Select the USB storage device, and select **Export**.

All user names and passwords are copied to the USB storage device. Passwords are encrypted.

### To import user accounts

- 1 Insert the USB storage device that contains the accounts.

- 2 Log in as Administrator.
- 3 Select **Import** on-screen.
- 4 Select the USB storage device, and select **Import**.
- 5 Restart the system.

All user names and passwords on the system are replaced with the imported data.

## Exporting and clearing the Event log

The Event log collects errors and events and can be exported to a USB storage device and read on a PC.

### To display the Event log

- 1 Log in as Administrator.
- 2 Select **Log** on-screen.

The Event log appears.

To return to the previous screen, select **Back**.

### To export the Event log

The Event log and the DICOM network log have the same file name (log.txt). Exporting either one to a USB storage device overwrites any existing log.txt file.

- 1 Insert a USB storage device.
- 2 Select **Log** and then select **Export** on-screen.  
A list of USB devices appears.
- 3 Select the USB storage device, and select **Export**.

The Event log is a text file that you can open in a text-editing application (for example, Microsoft Word or Notepad).

### To clear the Event log

- 1 Display the Event log.
- 2 Select **Clear** on-screen.
- 3 Select **Yes**.

## Logging in as user

If user login is required, the User Login screen appears when you turn on the system. (See “[To require user login](#)” on page 16.)

### To log in as user

- 1 Turn on the system.
- 2 In the **User Login** screen, type your name and password, and select **OK**.

### To log in as guest

Guests can scan but can't access system setup and patient information.

- 1 Turn on the system.
- 2 In the **User Login** screen, select **Guest**.

### To change your password

- 1 Turn on the system.
- 2 In the **User Login** screen, select **Password**.
- 3 Type your old and new passwords, confirm the new password, and then select **OK**.

## Choosing a secure password

To ensure security, choose a password that contains uppercase characters (A-Z), lowercase characters (a-z), and numbers (0-9). Passwords are case-sensitive.

## Annotations setup

On the Annotations setup page, you can customize predefined labels and set the preference for managing text when unfreezing images.

For instructions to annotate images, see “[Annotating images](#)” on page 39.

### To predefine a label group

You can specify which labels are available for an exam type when annotating an image. (See “[To place text on an image](#)” on page 39.)

- 1 In the **Exam** list on the Annotations setup page, select the exam type whose labels you want to specify.
- 2 For **Group**, select **A**, **B**, or **C** for the label group you want associated with that exam.

The preset labels appear for the selected group.

- 3 Do any of the following:
  - Add a custom label to the group: Type the label in the **Text** box, and select **Add**.
  - Rename a label: Select the label, type the new name in the **Text** box, and select **Rename**.
  - Move a label within the group: Select the label, and then select the on-screen up or down arrow.
  - Delete a label from a group: Select the label, and select **Delete**.

You can use symbols in labels. See “[Symbols](#)” on page 11.

### To specify text retention when unfreezing

You can specify which text to keep when you unfreeze an image or change the imaging layout.

- ❖ In the **Unfreeze** list on the Annotations setup page, select **Keep All Text**, **Keep Home Text**, or **Clear All Text**.

The default setting is **Keep All Text**. For information on setting the home position, see “[To reset the home position](#)” on page 40.

### To export predefined label groups

- 1 Insert a USB storage device.
- 2 On the Annotations setup page, select **Export**.  
A list of USB devices appears.
- 3 Select the USB storage device, and select **Export**.

A copy of all predefined label groups for all exams saves to the USB storage device.

## To import predefined label groups

- 1 Insert the USB storage device that contains the label groups.
- 2 On the Annotations setup page, select **Import** on-screen.
- 3 Select the USB storage device, and then select **Import**.
- 4 Select **Done** in the dialog box that appears.

All predefined label groups for all exams are replaced with those from the USB storage device.

## Audio, Battery setup

On the Audio, Battery setup page, you can select options in the following lists:

**Key click** Select **On** or **Off** for keys to click when pressed.

**Beep alert** Select **On** or **Off** for the system to beep when saving, warning, starting, or shutting down.

**Sleep delay** Select **Off**, or **5** or **10** minutes to specify the period of inactivity before the system goes into sleep mode.

**Power delay** Select **Off**, or **15** or **30** minutes to specify the period of inactivity before the system automatically turns off.

## Cardiac Calculations setup

On the Cardiac Calculations setup page, you can specify measurement names that appear in the Tissue Doppler Imaging (TDI) calculations menu and on the report page.

See also “[Cardiac calculations](#)” on page 56.

### To specify cardiac measurement names

- ❖ Under **TDI Walls** on the Cardiac Calculations setup page, select a name for each wall.

## Connectivity setup

On the Connectivity setup page, you specify options for using non-USB devices and for alerts when internal storage is full. You also import wireless certificates and specify settings (including Transfer Mode and Location) for SiteLink™ Image Manager and DICOM®, which are optional features. For SiteLink issues, refer to the SiteLink Image Manager user guide. For DICOM issues, such as storage commitment, archivers, and MPPS, refer to *Sending and Receiving DICOM Data on SonoSite Systems*.

### To configure the system for a printer

- 1 Set up the printer hardware. (See instructions included with the printer or docking system.)
- 2 In the **Printer** list on the Connectivity setup page, select the printer.

### To configure the system for a DVD recorder, PC, or serial bar code scanner

- 1 On the Connectivity setup page, do the following:
  - (DVD recorder) In the **Video Mode** list, select the video standard: **NTSC** or **PAL**.
  - In the **Serial Port** list, select the peripheral.

**Computer (PC)** allows patient report data to be sent as ASCII text from the system to a PC. The PC must have third-party software to acquire, view, or format the data into a report. Check the compatibility of your software with SonoSite Technical Support. (See also “[To send a patient report to a PC](#)” on page 77.)

*Note: Because these peripherals use the same RS-232 connector on the mini-dock, you can connect only one of them at a time.*

- 2 Restart the system.

- 3 Attach a serial cable (RS-232) from the serial port on the mini-dock or docking system to the peripheral.

### To receive storage alerts

- ❖ On the Connectivity setup page, select **Internal Storage Capacity Alert**.

The system displays a message if internal storage is near capacity when you end an exam. The system then deletes archived patient exams if specified in DICOM.

## Date and Time setup

**WARNING:** To obtain accurate obstetrics calculations, an accurate date and time are critical. Verify that the date and time are accurate before each use of the system. The system does not automatically adjust for daylight saving time changes.

### To set the date and time

- ❖ On the Date and Time setup page, do the following:
  - In the **Date** box, type the current date.
  - In the **Time** box, type the current time in 24 hour format (hours and minutes).

## Display Information setup

On the Display Information setup page, you can specify which details appear on-screen during imaging. You can select settings in the following sections:

**Patient Header** Information that appears in the patient header.

**Mode Data** Imaging information.

**System Status** System status information.

## IMT Calculations setup

On the IMT Calculations setup page, you can customize the IMT calculations menu. You can specify up to eight measurement names for both right side and left side calculations. The measurement names also appear in the patient report.

See also “[IMT calculations](#)” on page 67.

### To customize the IMT calculations menu

- ❖ On the IMT Calculations setup page, do the following:
  - Under **IMT Calculations**, select measurement names from the lists, or select **None**.

The selected names appear in the calculations menu and in the patient report.
  - Type the desired width in the **Region width (mm)** box.

## Network Status setup

The Network Status setup page displays information on system IP address, Location, Ethernet MAC address, and the wireless connection if any.

## OB Calculations setup

On the OB Calculations setup page, you select authors for OB calculation tables. You can also import or export additional OB calculation tables.

See also “[OB calculations](#)” on page 69.

### To specify gestational age and growth analysis

- 1 On the OB Calculations setup page, select the desired OB authors (or select **None**) in the



measurement lists under **Gestational Age** and **Growth Analysis**.

Selecting an author places the associated measurement on the calculations menu.

- 2 (Optional) Select **More** to display the list of user-defined custom measurements and to associate a custom table for the custom measurement.

This option is available only when a user-defined custom table has been created for the custom measurement.

### To export OB calculation tables

- 1 Insert a USB storage device.
- 2 On the OB Calculations setup page, select **Export**. A list of USB devices appears.
- 3 Select the USB storage device, and select **Export**.

All user-defined tables and measurements are copied to the USB storage device.

### To import OB calculation tables

Tables that you import are added to those already on the system.

- 1 Insert the USB storage device that contains the tables.
- 2 On the OB Calculations setup page, select **Import** on-screen.
- 3 Select the USB storage device, and then select **Import**.
- 4 Select **OK** in the dialog box that appears.

The system restarts.

## OB Custom Measurements setup

On the OB Custom Measurements setup page, you can define measurements that appear in the OB calculations menu and OB report. OB Custom Measurements is an optional feature.

See also “OB calculations” on page 69.

### To set up OB custom measurements

You can save up to five custom measurements that appear in the OB calculations menu and OB report.

- 1 On the OB Custom Measurements setup page, select **New**.
- 2 In the **Name** box, type a unique name.
- 3 In the **Type** list, select the desired measurement type.
- 4 Select **Save**.

### To delete an OB custom measurement

If you delete an OB custom measurement during an exam, the exam ends.

- 1 On the OB Custom Measurements setup page, highlight the measurement in the **Custom Measurements** list.
- 2 Select **Delete Last**.
- 3 Select **Yes**.

The exam ends, and any tables and report data associated with the measurement are removed from the system.

## OB Custom Tables setup

On the OB Custom Tables setup pages, you can customize growth tables that appear in the calculations menu and patient report.

**Gestational Age Table Measurements** The system provides gestational age measurements by selected authors for GS, CRL, BPD, OFD, HC, TTD, APTD, AC, FTA, FL, EFW, Tibia, HL, and 5 additional custom measurement labels.

**Growth Analysis Table Measurements** The system provides growth graphs or curves for BPD, HC, AC, FL, EFW, and HC/AC.

**WARNING:** Prior to use, verify that custom table data entries are correct. The system does not confirm the accuracy of the custom table data entered by the user.

### To view OB tables

- 1 On the OB Calculations or OB Custom Measurements setup page, select **Tables** on-screen.
- 2 Select the desired table and measurement/author.

### To create a new OB custom table

You can create two custom tables for each OB measurement.

- 1 On the OB Calculations or OB Custom Measurements setup page, select **Tables** on-screen.
- 2 Select the desired table (**Gestational Age** or **Growth Analysis**).
- 3 In the **Measurement** list, select the measurement for the custom table.
- 4 Select **New** on-screen.
- 5 In the **Author** box, type a unique name.
- 6 Enter the data.
- 7 Select **Save** on-screen.

To display the measurement for the custom table in the calculations menu, see [“To specify gestational age and growth analysis”](#) on page 20.

### To edit or delete an OB custom table

- 1 On the OB Calculations or OB Custom Measurements setup page, select **Tables** on-screen.
- 2 Select the OB custom table.
- 3 Select one of the following on-screen:
  - **Edit** Enter data, and then select **Save** on-screen.
  - **Delete** to remove the custom table. Select **Yes**.

## Presets setup

The Presets setup page has settings for general preferences. You can select from the following lists:

**Doppler Scale** Select **cm/s** or **kHz**.

**Duplex** The layout for displaying M Mode trace and Doppler spectral trace: **1/3 2D, 2/3 Trace; 1/2 2D, 1/2 Trace;** or **Full 2D, Full Trace**.

**Live Trace** Select **Peak** or **Mean**.

**Thermal Index** You can select **TIS**, **TIB**, or **TIC**. The default setting is based on exam type: OB is **TIB**, TCD is **TIC**, and all others are **TIS**.

**Save Key** Behavior of the SAVE key. **Image Only** saves the image to internal storage. **Image/Calcs** saves the image to internal storage and saves the current calculation to the patient report.

**Dynamic Range** Settings include **-3, -2, -1, 0, +1, +2,** or **+3**. Negative numbers show higher contrast images, and positive numbers show lower contrast images.

**Units** Units for patient height and weight in cardiac exams: **in/ft/lbs** or **cm/m/kg**.

**Language** The system language. Changing the language requires restarting the system.

**Color Scheme** The background color of the display.

**Auto save Pat. Form** Automatically saves the patient information form as an image in the patient's file.

## System Information setup

The System Information setup page displays system hardware and software versions, patents, and license information.

See also “[To enter a license key](#)” on page 82.

### To display patents

- ❖ On the System Information setup page, select **Patents**.

## USB Devices setup

On the USB Devices setup page, you can view information about connected USB devices, including space availability. You can also specify a file format for images and clips in patient exams that you export to a USB storage device. (See “[To export patient exams to a USB storage device](#)” on page 45.)

### To specify a file format for exported images

- 1 On the USB Devices setup page, select **Export**.
- 2 Under **USB Export**, select an export type:
  - **SiteLink** organizes files in a SiteLink-style folder structure. Clips export in H.264 video saved as MP4 files. To view them, SonoSite recommends QuickTime 7.0 or later.
  - **DICOM** creates files readable by a DICOM reader. DICOM is an optional feature.
- 3 Select an image format for your export type. For JPEG image format, also select a JPEG

compression. (See also “[Limitations of JPEG format](#).”)

A high compression has a smaller file size but less detail.

For SiteLink export type, the image format affects only still images. For DICOM export type, the image format affects both still images and clips.

- 4 For **SiteLink** export type, select a sort order under **Sort By**.

To return to the previous screen, select **Devices**.

### To include private tags

If you use DICOM export type and a SonoSite software product, include private tags on the images.

- ❖ On the USB Devices setup page, select **Include private tags**.

*Note: Because the tags may be incompatible with some earlier archivers, keep this check box unselected unless you use SonoSite software products. For more information, see M-Turbo System DICOM Conformance Statement.*

## Limitations of JPEG format

When transferring or exporting images in JPEG format, the system uses *lossy compression*. Lossy compression may create images that have less absolute detail than BMP format and that don't render identically to the original images.

In some circumstances, lossy-compressed images may be inappropriate for clinical use. For example, if you use images in SonoCalc® IMT software, you should transfer or export them using BMP format. SonoCalc IMT software uses a sophisticated algorithm to measure images, and lossy compression may cause errors.

For more information on using lossy-compressed images, consult the industry literature, including the following references:

“Physics in Medicine and Biology, Quality Assessment of DSA, Ultrasound and CT Digital Images Compressed with the JPEG Protocol,” D Okkalides et al 1994 Phys Med Biol 39 1407-1421 doi: 10.1088/0031-9155/39/9/008  
www.iop.org/EJ/abstract/0031-9155/39/9/008

“Canadian Association of Radiologists, CAR Standards for Irreversible Compression in Digital Diagnostic Imaging within Radiology,” Approved: June 2008.  
www.car.ca/Files/%5CLossy\_Compression.pdf

## eFilm Lite image-viewer

You can include a copy of the eFilm Lite image-viewer with exams that you export to a USB memory stick in DICOM format. eFilm Lite lets you view DICOM-formatted images on a computer running Windows.

eFilm Lite is a licensed feature.

**WARNING:** Russian characters may appear incorrectly in eFilm Lite. FUJIFILM SonoSite recommends that you do not use the eFilm Lite image-viewer to view exams exported in Russian.

## To start eFilm Lite image-viewer after exporting exams

- 1 Insert the USB memory stick into your computer.
- 2 Display the USB memory stick’s contents.
- 3 Double-click **eFilmLite.bat**.

**eFilmLite.bat** starts the executable file in the eFilmLite folder. The eFilmLite folder contains the eFilm Lite software and related files. See also the *eFilm Lite User’s Guide*, a PDF file in the eFilmLite folder.

# Chapter 3: Imaging

## Imaging modes

The system has a high-performance display and advanced image-optimization technology that significantly simplifies user controls. Imaging modes available depend on the transducer and exam type. See “[Imaging modes and exams available by transducer](#)” on page 34.

## 2D imaging

- WARNING:** To avoid incorrect needle placement when MBe is on:
- Using movement and fluid injection, verify the needle-tip location and trajectory. MBe enhances linear structures within a selected angle range on the ultrasound plane. Linear structures outside the selected angle range or the ultrasound plane—such as a bent needle—may be less apparent.
  - Note that linear structures are enhanced only in an outlined portion of the image. The area outside the outline remains unchanged. (See [Figure 2](#).)
  - Note that the beam divergence of a curved array transducer may prevent a segment of the needle shaft from showing in the image. (See [Figure 3](#).) The needle tip may not show.

2D is the system's default imaging mode. The system displays echoes in two dimensions by assigning a brightness level based on the echo signal amplitude. To achieve the best possible image quality, properly adjust the display

brightness, gain, depth settings, viewing angle, and exam type. Also, select an optimization setting that best matches your needs.

### To display the 2D image

- 1 Do any of the following:
  - Turn on the system.
  - Press the 2D key.
- 2 Set options as desired. See “[2D options](#).”

### 2D options

In 2D imaging, you can select the following on-screen options.

#### Optimize



Settings are as follows:

- **Res** provides the best possible resolution.
- **Gen** provides a balance between resolution and penetration.
- **Pen** provides the best possible penetration.

Some of the parameters optimized to provide the best image include focal zones, aperture size, frequency (center and bandwidth), and waveform. They cannot be adjusted by the user.

#### Dynamic Range



Adjusts the grayscale range: **-3, -2, -1, 0, +1, +2, +3**.

The positive range increases the number of grays displayed, and the negative range decreases the number of grays displayed.

---

**Dual**

Displays side-by-side 2D images. Select **Dual**, and then press the UPDATE key to display the second screen and to toggle between the screens. With both images frozen, press the UPDATE key to toggle between the images. To return to full-screen 2D imaging, select **Dual** or press the 2D key.

---

**LVO On,  
LVO Off**

**LVO On** turns on Left Ventricular Opacification. **LVO Off** turns off this option. Use LVO for cardiac exams in 2D imaging mode when using an imaging contrast agent. LVO lowers the mechanical index (MI) of the system to enhance visualization of the contrast agent and endocardial border. This option depends on transducer and exam type.

---

**Orientation**

Select from four image orientations: **U/R** (Up/Right), **U/L** (Up/Left), **D/L** (Down/Left), **D/R** (Down/Right).

---

**Brightness**

Adjusts the display brightness. Settings range from **1** to **10**. The display brightness affects battery life. To conserve battery life, adjust brightness to a lower setting.

---

**Guide**

Turns guidelines on and off. Guidelines are for needle guidance, are an optional feature, and depend on transducer type. For transducers with a single-angle or multi-angle bracket, the touchpad moves the depth cursor. If the transducer uses a multi-angle bracket, select **Guide** and then select the angle: **A**, **B**, or **C**. To exit angle selection, select **Back**. To clear the guides, do either of the following:

- Select the angle again (**A**, **B**, or **C**).
- Exit angle selection and press **Guide**.

See also the needle guide's user documentation.

---

**Sector**

(Cardiac exam) Specifies the sector width. SonoMB On is available only for **Sector Full**.

---

**SonoMB  
(MB)**

**MB On** and **MB Off** turn SonoMB™ multi-beam imaging technology on and off. When SonoMB is on, **MB** appears in the upper left-hand screen. SonoMB depends on transducer and exam type.

---

**ECG**

Displays the ECG trace. See [“ECG Monitoring”](#) on page 45. This feature is optional and requires a SonoSite ECG cable.

---

**Clips**

Displays the clips options. See [“To capture and save a clip”](#) on page 42. This feature is optional.

---

<b>THI</b>	Turns Tissue Harmonic Imaging on and off.
	When on, <i>THI</i> appears in the upper left-hand screen. This feature depends on transducer and exam type.

---

<b>Page x/x</b>	Indicates which page of options is displayed. Select to display the next page.
-----------------	--

---

## 2D controls

---

**MBe** Turns on SonoMBe imaging, which enhances linear structures within a selected angle range and can facilitate needle guidance during catheter placement and nerve-block procedures. A three- or four-sided outline indicates the affected area. (See [Figure 2.](#))

For curved array transducers, MBe can help identify the direction of the needle, although only segments of the needle shaft may show in the image. (See [Figure 3.](#)) Use movement and fluid injection to help verify the needle-tip location.

Use a 17-gauge to 25-gauge needle (recommended). Enhancement results can depend on the type and brand of needle used. For more information, consult the medical literature on needle visibility in ultrasound-guided procedures.

You can angle the needle up to 50° from the transducer surface. (See [Figure 1.](#)) Beyond 50°, the needle may be less enhanced. (MBe has little or no benefit to out-of-plane procedures. MBe is intended for in-plane procedures only.)

Avoid setting the gain too high, as unnecessarily high gain can cause artifacts in the image. Also, respiratory and cardiac movement in the image may cause bright pulsating artifacts.

When MBe is on, additional controls are available:

- **L/R Flip** flips the affected area (the outline) horizontally on the image.

For reorienting the entire image, use the orientation control .

- **Shallow, Medium, or Steep** sets the outline's sloped edge, which is indicated by a dotted line.
- Linear transducer: Use whichever setting provides best perpendicularity to the dotted line. Within the affected area, the more perpendicular that a linear structure is to the dotted line, the more it is enhanced. Similarly, the less perpendicular (and more parallel) that a linear structure is to the dotted line, the less it is enhanced.
- Curved array transducer: For a linear structure angled 30° or less from the transducer surface, use Shallow for best enhancement. For a linear structure angled 30-40°, use Medium. For a linear structure angled 40° or greater, use Steep.

The current selection is highlighted green.

- **Off** turns off MBe. Temporarily turning off MBe can help you identify artifacts and other structures not of interest.
- **Back** returns to the previous screen. If MBe is on, **MBe** is highlighted green and *MBe* appears in the mode data area. Pressing **MBe** again redisplay the MBe controls.

Available in Breast, Musculoskeletal, Nerve, Small Parts, Vascular (L25x only), and Venous (L25x only) exams and in full-screen imaging only. If MBe is on, the MB control is unavailable.

**Tip:** If you use MBe frequently, use a shortcut key to turn on the MBe control.

**Tip:** For instructions to program a shortcut key, see "A & B Key, Footswitch setup" on page 15.

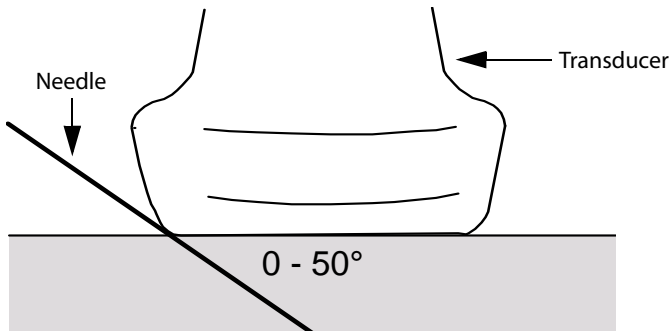

Figure 1. **MBe** transducer

**Tip:** For best results, angle the needle only up to 50° from the transducer surface.



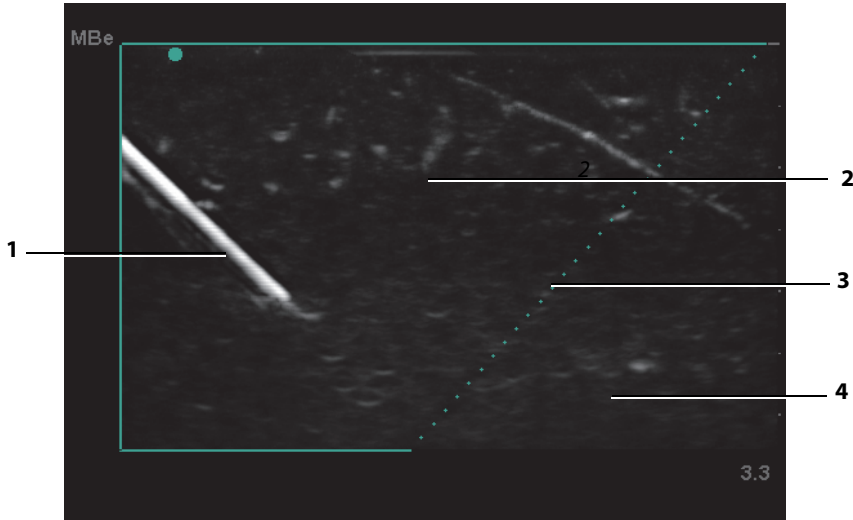

Figure 2: MBe image with MBe on (linear transducer)

- |                                 |                   |
|---------------------------------|-------------------|
| 1 Needle                        | 3 Dotted line     |
| 2 Outlined area affected by MBe | 4 Unenhanced area |

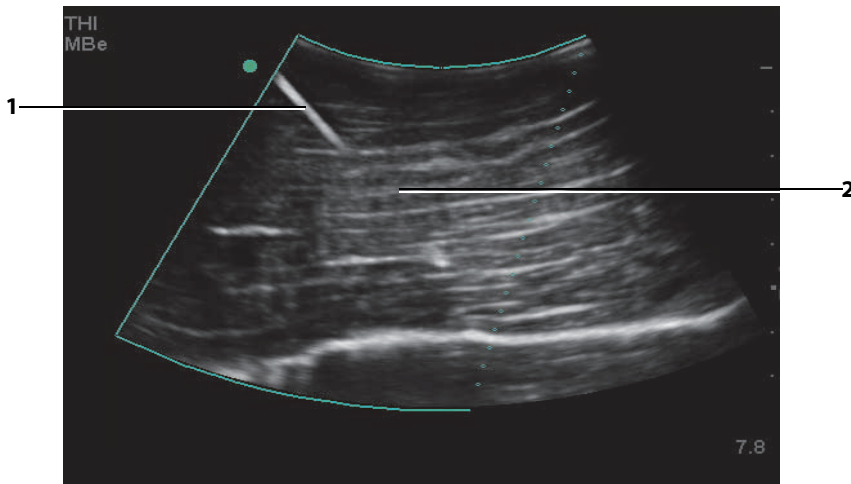

Figure 3: MBe image with a curved array transducer

**Tip:** With a curved array transducer, only segments of the needle shaft might show.

- |                      |   |
|----------------------|---|
| 1 Upper needle shaft | 2 Unshown segment of needle shaft<br>(unshown segment or segments depend on specific image) |
|----------------------|---|

## M Mode imaging

Motion mode (M Mode) is an extension of 2D. It provides a trace of the 2D image displayed over time. A single beam of ultrasound is transmitted, and reflected signals are displayed as dots of varying intensities, which create lines across the screen.

### To display the M-line

- 1 Press the M MODE key.

*Note: If the M-line does not appear, make sure that the image isn't frozen.*

- 2 Use the touchpad to position the M-line where desired.
- 3 Set options as desired.

Many optimization and depth options available in 2D imaging are also available in M Mode imaging. See “2D options” on page 25.

### To display the M Mode trace

- 1 Display the M-line.
- 2 Adjust the depth if necessary. (See “To adjust depth” on page 33.)
- 3 Press the M MODE key.

The time scale above the trace has small marks at 200ms intervals and large marks at one-second intervals.

- 4 Do any of the following as needed:

- Select the sweep speed  $\rightarrow$  (Slow, Med, or Fast).
- Press the UPDATE key to toggle between the M-line and M-Mode trace.
- If using a duplex layout, press the M MODE key to toggle between the full-screen M-line and the duplex layout.

To set a duplex layout, see “Presets setup” on page 22.

## CPD and color Doppler imaging

Color power Doppler (CPD) and color Doppler (Color) are optional features.

CPD is used to visualize the presence of detectable blood flow. Color is used to visualize the presence, velocity, and direction of blood flow in a wide range of flow states.

### To display the CPD or Color image

- 1 Press the COLOR key.

A ROI box appears in the center of the 2D image.

- 2 Select **CPD** or **Color**.

The current selection also appears in the upper left-hand screen.

The Color indicator bar on the upper left-hand screen displays velocity in cm/s in Color imaging mode only.

- 3 Using the touchpad, position or resize the ROI box as needed. Press the SELECT key to toggle between position and size.

While you position or resize the ROI box, a green outline shows the change. The ROI box indicator on the left-hand screen shows which touchpad function is active.

- 4 Set options as desired. See “CPD and Color options.”

### CPD and Color options

In CPD or Color imaging, you can set the following on-screen options.

---

#### Color, CPD



Toggle between CPD and Color.

The current selection appears in the upper left-hand screen.







---

#### Color Suppress



Shows or hides color information. You can select **Show** or **Hide** while in live or frozen imaging. The setting shown on-screen is the current selection.

---

<b>Flow Sensitivity</b> 	<p>The current setting appears on-screen.</p> <ul style="list-style-type: none"> <li>• <b>Low</b> optimizes the system for low flow states.</li> <li>• <b>Med</b> optimizes the system for medium flow states.</li> <li>• <b>High</b> optimizes the system for high flow states.</li> </ul>
<b>PRF Scale</b> 	<p>Select the desired pulse repetition frequency (PRF) setting by pressing the control keys.</p> <p>There is a wide range of PRF settings for each Flow Sensitivity setting (Low, Med, and High). Available on select transducers.</p>
<b>Wall Filter</b> 	<p>Settings include <b>Low, Med, and High</b>. Available on select transducers.</p>
<b>Steering</b> 	<p>Select the steering angle setting of the color ROI box (<b>-15, 0, or +15</b>). If adding PW Doppler, see “<a href="#">PW Doppler options</a>” on page 32. Available on select transducers.</p>
<b>Variance</b> 	<p>Turns variance on and off. Available only for cardiac exam.</p>
<b>Invert</b> 	<p>Switches the displayed direction of flow. Available in Color imaging.</p>
<b>Sector</b> 	<p>(Cardiac exam) Specifies the sector width.</p>
<b>Page x/x</b>	<p>Indicates which page of options is displayed. Select to display the next page.</p>

## PW and CW Doppler imaging

Pulsed wave (PW) Doppler and continuous wave (CW) Doppler imaging modes are optional features.

PW Doppler is a Doppler recording of blood flow velocities in a range specific area along the length of the beam. CW Doppler is a Doppler recording of blood flow velocities along the length of the beam.

You can use PW/CW Doppler and CPD/Color simultaneously. If CPD/Color imaging is on, the color ROI box is tied to the D-line. The SELECT key cycles among color ROI box position; color ROI box size; the D-line and gate location; and (in PW Doppler) angle correction. The active selection is green. Also, the indicator on the left-hand screen shows which touchpad function is active.

### To display the D-line

The default Doppler imaging mode is PW Doppler. In cardiac exams, you can select the CW Doppler on-screen option.

- 1 Press the DOPPLER key.

*Note: If the D-line does not appear, make sure that the image isn't frozen.*

- 2 Do any of the following as needed:
  - Set options. See “[PW Doppler options](#)” on page 32.
  - Using the touchpad, position the D-line and gate where desired. Horizontal movements position the D-line. Vertical movements position the gate.
  - (PW Doppler) To correct the angle manually, do one of the following:
    - Press the SELECT key and then use the touchpad. The SELECT key toggles between the D-line and angle correction.
    - Freeze the image, and then turn the  knob.

You can adjust the angle in 2° increments from -74° to +74°.

## Cardiac imaging applications

You can identify the presence and location of fluid around the heart and lungs, use to assist in pericardiocentesis and thoracentesis procedures, visualize blood flow through cardiac valves, and detect normal lung motion for the presence or absence of pathology.

### To display the spectral trace

- 1 Display the D-line.
- 2 Press the DOPPLER key.

The time scale above the trace has small marks at 200 ms intervals and large marks at one-second intervals.

- 3 Do any of the following as needed:

- Set options. See [“Spectral trace options”](#) on page 32.
- Press the UPDATE key to toggle between the D-line and spectral trace.
- If using a duplex layout, press the DOPPLER key to toggle between the full-screen D-line and the duplex layout.

To set a duplex layout, see [“Presets setup”](#) on page 22.

## PW Doppler options

In PW Doppler imaging, you can set the following on-screen options.

### PW, CW



(Cardiac exam only) Toggle between PW Doppler and CW Doppler.

The current selection appears in the upper left-hand screen.

### Angle Correction

Corrects the angle to 0°, +60°, or -60°.



### Gate Size



Settings depend on transducer and exam type.

In TCD or Orb exams, use the touchpad to specify the Doppler gate depth (the depth of the center of the gate in the Doppler image). The Doppler gate depth indicator is on the lower right-hand screen.

### TDI On, TDI Off

Select **TDI On** to turn on tissue Doppler imaging. When on, *TDI* appears in the upper left-hand screen. The default is **TDI off**. Available only in cardiac exams.

### Steering



Select the desired steering angle setting. Settings available depend on the transducer. The PW Doppler angle correction automatically changes to the optimum setting.

- **-15** and **-20** have an angle correction of -60°.
- **0** has an angle correction of 0°.
- **+15** and **+20** have an angle correction of +60°.

You can manually correct the angle after selecting a steering angle setting. (See [“To display the D-line”](#) on page 31.)

Available on select transducers.

### Page x/x

Indicates which page of options is displayed. Select to display the next page.







## Spectral trace options

In spectral trace imaging, you can set the following on-screen options.

### Scale



Select the desired scale (pulse repetition frequency [PRF]) setting. (To change the Doppler scale to cm/s or kHz, see [“Presets setup”](#) on page 22.)

<b>Line</b> 	Sets the baseline position. (On a frozen trace, the baseline can be adjusted if <b>Live Trace</b> is off.)
<b>Invert</b> 	Vertically flips the spectral trace. (On a frozen trace, <b>Invert</b> is available if <b>Live Trace</b> is off.)
<b>Volume</b> 	Increases or decreases Doppler speaker volume ( <b>0-10</b> ).
<b>Wall Filter</b> 	Settings include <b>Low, Med, High</b> .
<b>Sweep Speed</b> 	Settings include <b>Slow, Med, Fast</b> .
<b>Live Trace</b> 	Displays a live trace of the peak or mean. (See “Presets setup” on page 22 to specify peak or mean.)
<b>Page x/x</b>	Indicates which page of options is displayed. Select to display the next page.

## Adjusting depth and gain

### To adjust depth

You can adjust the depth in all imaging modes but the trace modes. The vertical depth scale is marked in 0.5 cm, 1 cm, and 5 cm increments, depending on the depth.



- ❖ Press the following keys:
  - UP DEPTH key to decrease the displayed depth.
  - DOWN DEPTH key to increase the displayed depth.

As you adjust the depth, the maximum depth number changes in the lower right screen.

### To adjust gain automatically

- ❖ Press the AUTO GAIN key. The gain adjusts each time you press this key.

### To adjust gain manually

- ❖ Turn a gain knob:
  - NEAR  adjusts the gain applied to the near field of the 2D image.
  - FAR  adjusts the gain applied to the far field of the 2D image.
  - GAIN  adjusts the overall gain applied to the entire image. In CPD or Color imaging, the GAIN knob affects the color gain applied to the region of interest (ROI) box. In PW and CW Doppler imaging, the the GAIN knob affects Doppler gain.

*Near* and *far* correspond to the time gain compensation (TGC) controls on other ultrasound systems.

## Freezing, viewing frames, and zooming

### To freeze or unfreeze an image

- ❖ Press the FREEZE key.  
On a frozen image, the cine icon and frame number appear in the system status area.

### To move forward or backward in the cine buffer

- ❖ Freeze the image, and do one of the following:
  - Turn the  knob.
  - Use the touchpad. Right moves forward, and left moves backward.
  - Press the LEFT ARROW and RIGHT ARROW keys.

The frame number changes as you move forward or backward. The total number of

frames in the buffer appears on-screen in the system status area.

### To zoom in on an image

You can zoom in 2D and Color imaging. You can freeze or unfreeze the image or change the imaging mode at any time while zooming.

- 1 Press the ZOOM key. A ROI box appears.
- 2 Using the touchpad, position the ROI box as desired.
- 3 Press the ZOOM key again.

The image in the ROI box is magnified by 100%.

- 4 (Optional) If the image is frozen, use the touchpad or arrow keys to pan the image up, down, left, and right. (You cannot pan in Dual.)

To exit zoom, press the ZOOM key again.

## Imaging modes and exams available by transducer

### WARNING:

To prevent misdiagnosis or harm to the patient, understand your system's capabilities prior to use. The diagnostic capability differs for each transducer, exam type, and imaging mode. In addition, transducers have been developed to specific criteria depending on their physical application. These criteria include biocompatibility requirements.

To avoid injury to the patient, use only an Orbital (Orb) or Ophthalmic (Oph) when performing imaging through the eye. The FDA has established lower acoustic energy limits for ophthalmic use. The system will not exceed these limits only if the Orb or Oph exam type is selected.

The transducer you use determines which exam types are available. In addition, the exam type you select determines which imaging modes are available.

### To change the exam type

- ❖ Do one of the following:
  - Press the EXAM key, and select from the menu.
  - On the patient information form, select from the **Type** list under **Exam**. (See ["Patient information form"](#) on page 40.)

## Imaging modes and exams available by transducer

Transducer	Exam Type <sup>1</sup>	Imaging Mode					
		2D <sup>2</sup> M Mode	MBe	CPD <sup>3</sup>	Color <sup>3</sup>	PW Doppler <sup>4</sup>	CW Doppler
C8x	Pros	✓	—	✓	✓	✓	—
C11x	Abd	✓	—	✓	✓	✓	—
	Neo	✓	—	✓	✓	✓	—
	Nrv	✓	—	✓	✓	✓	—
	Vas	✓	—	✓	✓	✓	—
C60x	Abd	✓	—	✓	✓	✓	—
	Gyn	✓	—	✓	✓	✓	—
	Msk	✓	✓	✓	✓	✓	—
	Nrv	✓	✓	✓	✓	✓	—
	OB	✓	—	✓	✓	✓	—
D2x	Crd	—	—	—	—	—	✓
HFL38x	Bre	✓	✓	✓	✓	✓	—
	IMT	✓	—	✓	✓	✓	—
	Msk	✓	✓	✓	✓	✓	—
	Nrv	✓	✓	✓	✓	✓	—
	SmP	✓	✓	✓	✓	✓	—
	Vas	✓	—	✓	✓	✓	—
	Ven	✓	—	✓	✓	✓	—
HFL50x	Bre	✓	✓	✓	✓	✓	—
	MSK	✓	✓	✓	✓	✓	—
	Nerve	✓	✓	✓	✓	✓	—

### Imaging Mode

<b>Transducer</b>	<b>Exam Type<sup>1</sup></b>	<b>2D<sup>2</sup> M Mode</b>	<b>MBe</b>	<b>CPD<sup>3</sup></b>	<b>Color<sup>3</sup></b>	<b>PW Doppler<sup>4</sup></b>	<b>CW Doppler</b>
	SmP	✓	✓	✓	✓	✓	—



## Imaging Mode

Transducer	Exam Type <sup>1</sup>	2D <sup>2</sup> M Mode	MBe	CPD <sup>3</sup>	Color <sup>3</sup>	PW Doppler <sup>4</sup>	CW Doppler
ICTx	Gyn	✓	—	✓	✓	✓	—
	OB	✓	—	✓	✓	✓	—
L25x	Msk	✓	✓	✓	✓	✓	—
	Nrv	✓	✓	✓	✓	✓	—
	Oph	✓	—	✓	✓	✓	—
	Sup	✓	—	✓	✓	✓	—
	Vas	✓	✓	✓	✓	✓	—
	Ven	✓	✓	✓	✓	✓	—
L38x	Bre	✓	—	✓	✓	✓	—
	IMT	✓	—	✓	✓	✓	—
	Nrv	✓	—	✓	✓	✓	—
	SmP	✓	—	✓	✓	✓	—
	Vas	✓	—	✓	✓	✓	—
	Ven	✓	—	✓	✓	✓	—
L38xi	Bre	✓	—	✓	✓	✓	—
	IMT	✓	—	✓	✓	✓	—
	Msk	✓	—	✓	✓	✓	—
	Nrv	✓	✓	✓	✓	✓	—
	SmP	✓	—	✓	✓	✓	—
	Vas	✓	—	✓	✓	✓	—
	Ven	✓	—	✓	✓	✓	—
P10x	Abd	✓	—	✓	✓	✓	—
	Crđ	✓	—	—	✓	✓	✓

### Imaging Mode

Transducer	Exam Type <sup>1</sup>	2D <sup>2</sup> M Mode	MBe	CPD <sup>3</sup>	Color <sup>3</sup>	PW Doppler <sup>4</sup>	CW Doppler
	Neo	✓	—	✓	✓	✓	—
P21x	Abd	✓	—	✓	✓	✓	—
	Crđ	✓	—	—	✓	✓	✓
	OB	✓	—	✓	✓	✓	—
	Orb	✓	—	✓	✓	✓	—
	TCD	✓	—	✓	✓	✓	—

## Imaging Mode

Transducer	Exam Type <sup>1</sup>	2D <sup>2</sup> M Mode	MBe	CPD <sup>3</sup>	Color <sup>3</sup>	PW Doppler <sup>4</sup>	CW Doppler
SLAx	Msk	✓	—	✓	✓	✓	—
	Nrv	✓	—	✓	✓	✓	—
	Sup	✓	—	✓	✓	✓	—
	Vas	✓	—	✓	✓	✓	—
	Ven	✓	—	✓	✓	✓	—
TEEx	Crđ	✓	—	—	✓	✓	✓

1. Exam type abbreviations are as follows: Abd = Abdomen, Bre = Breast, Crđ = Cardiac, Gyn = Gynecology, IMT = Intima Media Thickness, Msk = Musculoskeletal, Neo = Neonatal, Nrv = Nerve, OB = Obstetrical, Oph = Ophthalmic, Orb = Orbital, SmP = Small Parts, Sup = Superficial, TCD = Transcranial Doppler, Vas = Vascular, Ven = Venous, Pros = Prostate.
2. The optimization settings for 2D are Res, Gen, and Pen.
3. The optimization settings for CPD and Color are low, medium, and high (flow sensitivity) with a range of PRF settings for Color depending on the setting selected.
4. For the cardiac exam type, PW TDI is also available. See [“PW Doppler options”](#) on page 32.

## Annotating images

You can annotate live images as well as frozen images. (You cannot annotate a saved image.) You can place text (including predefined labels), an arrow, or a pictograph. To set preferences for annotations, see [“Annotations setup”](#) on page 18.

### To place text on an image

You can place text in the following imaging layouts: full-screen 2D, full-screen trace, dual, or duplex. You can place text manually or add a predefined label.

- 1 Press the **TEXT** key. A green cursor appears.
- 2 Move the cursor where desired:
  - Use the touchpad or arrow keys.



- Select **Home** to move the cursor to the home position.

The default home position depends on the imaging screen layout. You can reset the home position. See [“To reset the home position”](#) on page 40.

- 3 Using the keyboard, type text.

- The arrow keys move the cursor left, right, up, and down.
- The **DELETE** key deletes all text.
- The **✕ Word** option removes a word.
- Select **Symbols** to enter special characters. See [“Symbols”](#) on page 11.

- (Optional) To add a predefined label, select **Label**, and then select the desired label group:

, , or . Select the group again for the desired label.

The first number shows which label in the group is selected. The second number is the number of labels available.

See “[Annotations setup](#)” on page 18.

To turn off text entry, press the **TEXT** key.

### To reset the home position

- Press the **TEXT** key.
- Using the touchpad or arrow keys, position the cursor where desired.
- Select **Home/Set**.

### To place an arrow on an image

You can add an arrow graphic to point out a specific part of the image.

- Press the **ARROW** key .
- If you need to adjust the arrow's orientation, press the **SELECT** key and then use the touchpad. When the orientation is correct, press the **SELECT** key again.
- Using the touchpad, position the arrow where desired.
- Press the **ARROW** key to set the arrow.

The arrow changes from green to white.

To remove the arrow, press the **ARROW** key and then select **Hide**.

### To place a pictograph on an image

The pictograph set available depends on transducer and exam type.

- Press the **PICTO** key.

- Select  **x/x** to display the desired pictograph, and then press the **SELECT** key.

The first number shows which pictograph in the set is selected. The second number is the number of pictographs available.

- Using the touchpad, position the pictograph marker.
- (Optional) To rotate the pictograph marker, press the **SELECT** key and then use the touchpad.
- Select a screen location for the pictograph: **U/L** (Up/Left), **D/L** (Down/Left), **D/R** (Down/Right), **U/R** (Up/Right).

In a duplex layout, the pictograph is restricted to upper left. In Dual, all four positions are available.

To remove the pictograph, select **Hide**.

## Patient information form

The patient information form lets you enter patient identification, exam, and clinical information for the patient exam. This information automatically appears in the patient report.

When you create a new patient information form, all images, clips, and other data you save during the exam are linked to that patient. (See “[Patient report](#)” on page 77.)

### To create a new patient information form

- Press the **PATIENT** key.
- Select  **New/End**.
- Fill in the form fields. See “[Patient information form fields](#)” on page 41.
- Select **Done**.

See also “[To append images and clips to a patient exam](#)” on page 44.

## To edit a patient information form

You can edit patient information if the exam has not been archived or exported and if the information is not from a worklist.

See also [“To edit patient information from the patient list”](#) on page 43.

- 1 Press the **PATIENT** key.
- 2 Make changes as desired.
- 3 Select one of the following:
  - **Cancel** to undo changes and return to imaging.
  - **Done** to save changes and return to imaging.

## To end the exam

- 1 Make sure that you have saved images and other data you want to keep. (See [“Saving images and clips”](#) on page 42.)
- 2 Press the **PATIENT** key.
- 3 Select  **New/End**.

A new patient information form appears.

## Patient information form fields

The patient information form fields available depend on exam type. In some fields you can select Symbols to enter symbols and special characters. See [“Symbols”](#) on page 11.

### Patient

- **Last, First, Middle** Patient name
- **ID** Patient identification number
- **Accession** Enter number, if applicable.
- **Date of birth**
- **Gender**
- **Indications** Enter desired text
- **User** User initials

- **Procedure (button)** Available if the DICOM Worklist feature is licensed and configured. See the DICOM user guide.

Select **Back** to save entries and return to the previous screen.

### Exam

- **Type** Exam types available depend on transducer. See [“Imaging modes and exams available by transducer”](#) on page 34.
- **LMP Estab. DD** (OB or Gyn exam) In an OB exam, select **LMP** or **Estab. DD** and then enter either the date of the last menstrual period or the established due date. In a Gyn exam, enter the date of the last menstrual period. The LMP date must precede the current system date.
- **Twins** (OB exam) Select the **Twins** check box to display Twin A and Twin B measurements on the calculations menu and for access to Twin A and Twin B screens for previous exam data.
- **Previous Exams (button)** (OB exam) Displays fields for five previous exams. The date for a previous exam must precede the current system date. For twins, select **Twin A/B** to toggle between Twin A and Twin B screens. (If the **Twin A/B** option does not appear, select **Back**, and make sure that the **Twins** check box is selected.)

Select **Back** to save changes and return to the previous screen.
- **BP** (Cardiac, IMT, Orbital, Transcranial, or Vascular exam) Blood Pressure
- **HR** (Cardiac, Orbital, Transcranial, or Vascular exam) Heart Rate. Enter the beats per minute. Saving the heart rate using a measurement overwrites this entry.
- **Height** (Cardiac exam) The patient height in feet and inches or meters and centimeters. (To change the units, see [“Presets setup”](#) on page 22.)

- **Weight** (Cardiac exam) The patient weight in pounds or kilos. (To change the units, see “Presets setup” on page 22.)
- **BSA** (Cardiac exam) Body Surface Area. Automatically calculated after you enter height and weight.
- **Ethnicity** (IMT exam) Ethnic origin
- **Reading Dr.**
- **Referring Dr.**
- **Institution**

## Images and clips

### Saving images and clips

When you save an image or clip, it saves to internal storage. The system beeps afterward if Beep Alert is on, and the percentage icon flashes. (See “Audio, Battery setup” on page 19.) The percentage icon in the system status area shows the percentage of space used in internal storage. If you try to save an image or clip when no space remains, the system alerts you that internal storage is full. To resolve this issue, archive images and clips that you wish to keep, and then delete them from the system to free up space. To receive alerts when storage is near capacity, see “To receive storage alerts” on page 20.

To access saved images and clips, open the patient list. See “Reviewing patient exams” on page 43.

### To save an image

- ❖ Press the SAVE key.

The image saves to internal storage.

By default, the SAVE key saves only the image. As a shortcut during calculations, the SAVE key can save both the image to internal storage and the calculation to the patient report. See “Presets setup” on page 22.

### To capture and save a clip

Clips, an optional feature, lets you capture, preview, and save clips.

- 1 Set Clips options. (See “To set Clips options” on page 42.)
- 2 Press the CLIP key.

One of the following occurs:

- If **Prev/Off** is selected, the clip saves directly to internal storage.
- If **Prev/On** is selected, the clip plays back in preview mode. You can select any of the following on-screen:
  - A playback speed  $\Rightarrow$  (1x, 1/2x, 1/4x)
  - **Pause** to interrupt playback
  - **Left: x** or **Right: x** to remove frames from the left or right sides of the clip (where  $x$  is the beginning or ending frame number)
  - **Save** to save the clip to internal storage
  - **Delete** to delete the clip

### To set Clips options

Setting Clips options ensures that clips are captured to your specifications.

- 1 In 2D imaging mode, select **Clips** on-screen.
- 2 Set options as desired.

## Clips options

### Time, ECG



**Time** and **ECG** share the same location on-screen.

- With **Time**, capturing is based on number of seconds. Select the time duration.
- With **ECG**, capturing is based on the number of heart beats. Select the number of beats.

### Preview On, Preview Off



**PrevOn** and **PrevOff** turn the preview feature on and off.

- With **Prev/On**, the captured clip automatically plays on-screen. The clip can be trimmed, saved, or deleted.
- With **Prev/Off**, the clip saves to internal storage, and the trim and delete options are not available.

### Prospective, Retrospective



**Pro** and **Retro** determine how clips are captured:

- With **Pro**, a clip is captured prospectively, after you press the CLIP key.
- With **Retro**, a clip is captured retrospectively, from pre-saved data before you press the CLIP key.

## Reviewing patient exams

### Caution:

If the internal storage icon does not appear in the system status area, internal storage may be defective. Contact SonoSite Technical Support. (See “[SonoSite Technical Support](#)” on page 7.)

The patient list organizes saved images and clips in patient exams. You can delete, view, print, or archive exams. You can also copy them to a USB storage device.

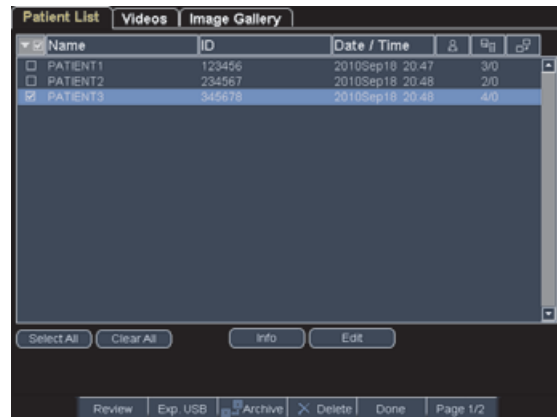

Figure 4 Patient List

### To display the patient list

- 1 Press the REVIEW key.
- 2 If there is an active exam, select **List** on-screen.

### To sort the patient list

After the system starts, the patient list is arranged by date and time, with the most recent patient file first. You can re-sort the patient list as needed.

- ❖ Select the column heading that you want to sort by. Select it again if sorting in reverse order.

*Note:* The  column heading is selectable.

### To select patients in the patient list

- ❖ Using the touchpad, select the check box for one or more patients.

**Select All** selects all patients.

To deselect patients, select checked boxes or **Clear All**.

### To edit patient information from the patient list

You can edit the patient name and ID from the patient list instead of from the patient information form if the exam is ended but has not been exported or archived.

- 1 In the patient list, select the patient.

- 2 Select **Edit**.
- 3 Fill in the form fields, and select **OK**.

### To append images and clips to a patient exam

Although you cannot add images and clips to a patient exam that is ended, you can automatically start a new patient exam that has the same patient information. Depending on your archiver, the two exams appear as one study when exported or archived.

- 1 Select the exam in the patient list.
- 2 Select **Append** on-screen.

A new patient information form appears. The form has the same information as the exam you selected.

### To review images and clips

You can review images and clips in only one patient exam at a time.

- 1 In the patient list, highlight the patient exam whose images and clips you want to review.
- 2 Select **Review** on-screen.
- 3 Select  **x/x** to cycle to the image or clip you want to review.
- 4 (Clip Only) Select **Play**.

The clip plays automatically after loading. The load time depends on clip length.

You can select **Pause** to freeze the clip and can select a playback speed  $\rightarrow$  **1x**, **1/2x**, **1/4x**.

- 5 Select  **x/x** to cycle to the next image or clip you want to view.

To return to the patient list, select **List**. To return to imaging, select **Done**.

## Printing, exporting, and deleting images and clips

- WARNING:** To avoid damaging the USB storage device and losing patient data from it, observe the following:
- Do not remove the USB storage device or turn off the ultrasound system while the system is exporting.
  - Do not bump or otherwise apply pressure to the USB storage device while it is in a USB port on the ultrasound system. The connector could break.

### To print an image

- 1 Verify that a printer is selected. See [“To configure the system for a printer”](#) on page 19.
- 2 Do one of the following:
  - In the patient list, review the patient’s images. Select **Print** when the image appears.
  - With the image displayed, press the A shortcut key.  
By default, the A shortcut key prints. To reprogram the A and B shortcut keys, see [“Presets setup”](#) on page 22.

### To print multiple images

- 1 Verify that a printer is selected. See [“To configure the system for a printer”](#) on page 19.
- 2 Do one of the following:
  - Print all images for multiple patients: Select one or more patients in the patient list. Then select **Print**.
  - Print all images for one patient: Highlight the patient in the patient list, and then select **Print**.



Each image appears briefly on-screen while printing.

### To export patient exams to a USB storage device

You can export patient exams if they are ended. (See “To end the exam” on page 41.)

A USB storage device is for temporary storage of images and clips. Patient exams should be archived regularly. To specify file format, see “USB Devices setup” on page 23.

- 1 Insert the USB storage device.
- 2 In the patient list, select the patient exams you want to export.
- 3 Select **Exp. USB** on-screen. A list of USB devices appears.
- 4 Select the USB storage device. If you want to hide patient information, deselect **Include patient information on images and clips**.

Only available USB devices are selectable.

- 5 Select **Export**.

The files are finished exporting approximately five seconds after the USB animation stops. Removing the USB storage device or turning off the system while exporting may cause exported files to be corrupted or incomplete. To stop in-progress exporting, select **Cancel Export**.

### To delete images and clips

- 1 Select one or more patients in the patient list.
- 2 Select **Delete** to delete the selected patients. A confirmation screen appears.

### To manually archive images and clips

You can send patient exams to a DICOM printer or archiver, or to a PC using SiteLink Image Manager. DICOM and SiteLink Image Manager are optional features. For more information about archiving, see the DICOM and SiteLink Image Manager documentation.

- 1 Select one or more patients in the patient list.
- 2 Select **Archive**.

### To display information about a patient exam

- 1 On the patient list, select the exam.
- 2 Select **Info**.

## ECG Monitoring

ECG Monitoring is an optional feature and requires a SonoSite ECG cable.

**WARNING:** To prevent misdiagnosis, do not use the ECG trace to diagnose cardiac rhythms. The SonoSite ECG option is a non-diagnostic feature.

To avoid electrical interference with aircraft systems, do not use the ECG cable on aircraft. Such interference may have safety consequences.

**Caution:** Use only accessories recommended by SonoSite with the system. Your system can be damaged by connecting an accessory not recommended by SonoSite.

*Note: Biopsy guidelines are not available when ECG is connected. The ECG signal may take up to one minute to restabilize after defibrillator use on the patient.*

### To monitor ECG

- 1 Connect the ECG cable to the ECG connector on the ultrasound system, mini-dock, or docking system.

ECG Monitoring turns on automatically.

*Note: An external ECG monitor may cause a lag in the timing of the ECG trace, corresponding with the 2D image. Biopsy guidelines are not available when ECG is connected.*

- 2 Select **ECG** on-screen. (**ECG** may be on another page. It appears only if the ECG cable is connected.)
- 3 Select options as desired.

### ECG Monitoring options

---

**Show/Hide** Turns on and off ECG trace.



**Gain** Increases or decreases ECG gain. Settings are **0-20**.



**Position** Sets the position of the ECG trace.

**Sweep Speed** Settings are **Slow, Med,** and **Fast**.



**Delay** Displays **Line** and **Save** for clip acquisition delay. (For instructions to capture clips, see ["To capture and save a clip"](#) on page 42.)

**Line** The position of the delay line on the ECG trace. The delay line indicates where the clip acquisition is triggered.



**Save** Saves the current position of the delay line on the ECG trace. (You can change the position of the delay line temporarily. Starting a new patient information form or cycling system power reverts the delay line to the most recently saved position.)  
Select **Delay** to display these options.

---

# Chapter 4: Measurements and Calculations

You can measure for quick reference, or you can measure within a calculation. You can perform general calculations as well as calculations specific to an exam type.

Measurements are performed on frozen images. For references used, see [Chapter 7, “References.”](#)

## Measurements

You can perform basic measurements in any imaging mode and can save the image with the measurements displayed. (See [“To save an image”](#) on page 42.) Except for the M Mode HR measurement, the results do not automatically save to a calculation and the patient report. If you prefer, you can first begin a calculation and then measure. See [“Performing and saving measurements in calculations”](#) on page 51.

Some options may not apply to your system. Options available depend on your configuration, transducer, and exam type.

### To save a measurement to a calculation and patient report

- 1 With the measurement active (green), press the CALCS key.
- 2 From the calculations menu, select a measurement name.

Only measurement names available for the imaging mode and exam type are selectable.

- 3 Save the calculation. (See [“To save a calculation”](#) on page 51.)

To start a calculation before measuring, see [“Performing and saving measurements in calculations”](#) on page 51.

### Working with calipers

When measuring, you work with calipers, often in pairs. Results based on the calipers’ position appear at the bottom of the screen. The results update as you reposition the calipers by using the touchpad. In trace measurements, the results appear after you complete the trace.

Outside a calculation, you can add calipers by pressing the CALIPER key. You can have multiple sets of calipers and can switch from one set to another, repositioning them as needed. Each set shows the measurement result. The active calipers and measurement result are highlighted green. A measurement is complete when you finish moving its calipers.

Within a calculation, calipers appear when you select from the calculations menu. (See [“To select from the calculations menu”](#) on page 51.)

For an accurate measurement, accurate placement of calipers is essential.

### To switch the active calipers

- ❖ Do one of the following:
  - To switch the active caliper within a set, press the SELECT key.
  - To switch the active set when measuring outside a calculation, select **Switch** on-screen.

### To delete or edit a measurement

- ❖ With the measurement active (highlighted), do one of the following:
  - To delete, select **Delete** on-screen.
  - To edit, use the touchpad to move the calipers.

*Note: Trace measurements cannot be edited once set.*

## To improve precision of caliper placement

- ❖ Do any of the following:
  - Adjust the display for maximum sharpness.
  - Use leading edges (closest to the transducer) or borders for starting and stopping points.
  - Maintain a consistent transducer orientation for each type of measurement.
  - Make sure that the area of interest fills as much of the screen as possible.
  - (2D) Minimize the depth, or zoom.

## 2D measurements

The basic measurements that you can perform in 2D imaging are as follows:

- Distance in cm
- Area in cm<sup>2</sup>
- Circumference in cm

You can also measure area or circumference by tracing manually.

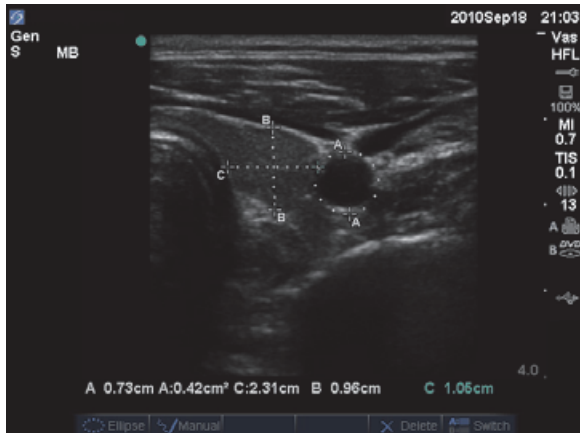

Figure 1 2D image with two distance and one circumference measurement

You can perform a combination of distance, area, circumference, and manual trace measurements at one time. The total number possible depends on their order and type.

### To measure distance (2D)

You can perform up to eight distance measurements on a 2D image.

- 1 On a frozen 2D image, press the CALIPER key.  
A pair of calipers appears, connected by a dotted line.
- 2 Using the touchpad, position the first caliper, and then press the SELECT key.

The other caliper becomes active.

- 3 Using the touchpad, position the other caliper.  
If you move the calipers close together, they shrink and the dotted line disappears.

See “To save a measurement to a calculation and patient report” on page 47.

### To measure area or circumference (2D)

- 1 On a frozen 2D image, press the CALIPER key.
- 2 Select **Ellipse** on-screen.

*Note: If you exceed the allowed number of measurements, Ellipse is not available.*

- 3 Use the touchpad to adjust the size and position of the ellipse. The SELECT key toggles between position and size.

See “To save a measurement to a calculation and patient report” on page 47.

### To trace manually (2D)

- 1 On a frozen 2D image, press the CALIPER key.
- 2 Select **Manual** on-screen.

*Note: If you exceed the allowed number of measurements, Manual is not available.*

- 3 Using the touchpad, position the caliper where you want to begin.

- 4 Press the SELECT key.
- 5 Using the touchpad, complete the trace, and press the SET key.

See [“To save a measurement to a calculation and patient report”](#) on page 47.

## M Mode measurements

The basic measurements that you can perform in M Mode imaging are as follows:

- Distance in cm/Time in seconds
- Heart Rate (HR) in beats per minute (bpm)

The time scale above the trace has small marks at 200 ms intervals and large marks at one-second intervals.

### To measure distance (M Mode)

You can perform up to four distance measurements on an image.

- 1 On a frozen M Mode trace, press the CALIPER key.  
A single caliper appears.
- 2 Using the touchpad, position the caliper.
- 3 Press the SELECT key to display the second caliper.
- 4 Using the touchpad, position the second caliper.

See [“To save a measurement to a calculation and patient report”](#) on page 47.

### To measure heart rate (M Mode)

- 1 On a frozen M Mode trace, press the CALIPER key.
- 2 Select **HR** on-screen.  
A vertical caliper appears.
- 3 Using the touchpad, position the vertical caliper at the peak of the heartbeat.

- 4 Press the SELECT key.  
A second vertical caliper appears.

- 5 Using the touchpad, position the second vertical caliper at the peak of the next heartbeat.

See [“To save a measurement to a calculation and patient report”](#) on page 47. Saving the heart rate measurement to the patient report overwrites any heart rate entered on the patient information form.

See also [“To measure fetal heart rate \(M Mode\)”](#) on page 71.

## Doppler measurements

The basic measurements that you can perform in Doppler imaging are Velocity (cm/s), Pressure Gradient, Elapsed Time, +/x Ratio, Resistive Index (RI), and Acceleration. You can also trace manually or automatically.

For Doppler measurements, the Doppler scale must be set to cm/s. See [“Presets setup”](#) on page 22.

### To measure Velocity (cm/s) and Pressure Gradient (Doppler)

- 1 On a frozen Doppler spectral trace, press the CALIPER key.  
A single caliper appears.
- 2 Using the touchpad, position the caliper to a peak velocity waveform.

This measurement involves a single caliper from the baseline.

See [“To save a measurement to a calculation and patient report”](#) on page 47.

## To measure Velocities, Elapsed Time, +/- Ratio, Resistive Index (RI), and Acceleration (Doppler)

- 1 On a frozen Doppler spectral trace, press the CALIPER key.  
A single caliper appears.
- 2 Using the touchpad, position the caliper to a peak systolic waveform.
- 3 Press the SELECT key.  
A second caliper appears.
- 4 Using the touchpad, position the second caliper at the end diastole on the waveform.

See “To save a measurement to a calculation and patient report” on page 47.

## To measure time duration (Doppler)

- 1 On a Doppler spectral trace, press the CALIPER key.
- 2 Press **Time** on-screen.  
A vertical caliper appears.
- 3 Using the touchpad, position the caliper where desired, and press the SELECT key.  
A second caliper appears.
- 4 Using the touchpad, position the second caliper where desired, and press the SELECT key.

## To trace manually (Doppler)

- 1 On a frozen Doppler spectral trace, press the CALIPER key.
- 2 Select **Manual** on-screen.  
A single caliper appears.
- 3 Using the touchpad, position the caliper at the beginning of the desired waveform, and press the SELECT key.

If calipers are not positioned correctly, the result is inaccurate.

- 4 Using the touchpad, trace the waveform.  
To make a correction, select **Undo** on-screen, backtrack with the touchpad, or press the BACKSPACE key.
- 5 Press the SET key.  
The measurement results appear.

See “To save a measurement to a calculation and patient report” on page 47.

## To trace automatically (Doppler)

After tracing automatically, confirm that the system-generated boundary is correct. If you are not satisfied with the trace, obtain a high-quality Doppler spectral trace image, or trace manually. (See “To trace manually (Doppler)” on page 50.)

- 1 On a frozen Doppler spectral trace, press the CALIPER key.
- 2 Select **Auto** on-screen.  
A vertical caliper appears.
- 3 Using the touchpad, position the caliper at the beginning of the waveform.  
If calipers are not positioned correctly, the calculation result is inaccurate.
- 4 Press the SELECT key.  
A second vertical caliper appears.
- 5 Using the touchpad, position the second caliper at the end of the waveform.
- 6 Press the SET key.  
The measurement results appear.

See “To save a measurement to a calculation and patient report” on page 47.

## Automatic trace results

Depending on the exam type, the results from automatic tracing include the following:

- Velocity Time Integral (VTI)
- Peak Velocity (Vmax)

- Mean Pressure Gradient (PGmean)
- Mean Velocity on Peak Trace (Vmean)
- Pressure Gradient (PGmax)
- Cardiac Output (CO)
- Peak Systolic Velocity (PSV)
- Time Average Mean (TAM)\*
- +/× or Systolic/Diastolic (S/D)
- Pulsatility Index (PI)
- End Diastolic Velocity (EDV)
- Acceleration Time (AT)
- Resistive Index (RI)
- Time Average Peak (TAP)
- Gate Depth

## General calculations

Within calculations, you can save measurement results to the patient report. You can display, repeat, and delete measurements from a calculation. Some measurements can be deleted directly from the patient report pages. See “Patient report” on page 77.

Calculation packages depend on exam type and transducer.

### Calculations menu

The calculations menu contains measurements available for the imaging mode and exam type. After you perform and save a measurement, the result saves to the patient report. (See “Patient report” on page 77.) Also, a check mark appears next to the measurement name in the calculations menu. If you highlight the checked measurement name, the results appear below the menu. If you repeat the measurement, the results below the menu reflect either the last measurement or the average, depending on the measurement.

Menu items followed by ellipses (. . .) have sub-entries.

### To select from the calculations menu

- 1 On a frozen image, press the CALCS key.

The calculations menu appears.

- 2 Using the touchpad or arrow keys, highlight the desired measurement name.

To display additional measurement names, highlight **Next**, **Prev**, or a measurement name that has ellipses (. . .). Then press the SELECT key.

Only measurement names available for the imaging mode are selectable.

- 3 Press the SELECT key.

To close the calculations menu, press the CALCS key once (if the menu is active) or twice (if the menu is inactive).

### Performing and saving measurements in calculations

In performing a measurement within a calculation, you select from the calculations menu, position the calipers that appear, and then save the calculation. Unlike measurements performed outside a calculation, the calipers appear by selecting from the calculations menu, not by pressing the CALIPER key. The type of calipers that appear depends on the measurement.

### To save a calculation

- ❖ Do one of the following:

- Save the calculation only: Press the SAVE CALC key, or select **Save** on-screen.

The calculation saves to the patient report. To save the image with the measurements displayed, see “To save an image” on page 42.

- Save both the image and calculation: Press the SAVE key if the SAVE key functionality

is set to **Image/Calcs**. (See “Presets setup” on page 22.)

The calculation saves to the patient report, and the image saves to internal storage with the measurements displayed.

## Displaying, repeating, and deleting saved measurements in calculations

### To display a saved measurement

- ❖ Do one of the following:
  - Highlight the measurement name in the calculations menu. The result appears below the menu.
  - Open the patient report. See “Patient report” on page 77.

### To repeat a saved measurement

- 1 Highlight the measurement name in the calculations menu.
- 2 Press the SELECT key or the CALIPER key.
- 3 Perform the measurement again.

The new results appear on-screen in the measurement and calculations data area. (See “Screen layout” on page 7.) You can compare them to the saved results below the menu.

- 4 To save the new measurement, press the SAVE CALC key.

The new measurement saves to the patient report and overwrites the previously saved measurement.

### To delete a saved measurement

- 1 Select the measurement name from the calculations menu.
- 2 Select **Delete** on-screen.

The measurement last saved is deleted from the patient report. If it is the only measurement, the check mark is deleted from the calculations menu.

Some measurements can be deleted directly from the patient report pages. See “Patient report” on page 77.

## EMED calculations

The results from EMED calculations automatically appear in the EMED worksheets. All EMED calculations are available for each exam type.

### To perform an EMED calculation:

- 1 Press the CALCS key.
- 2 Select **EMED** on-screen.

The calculations menu becomes the EMED calculations menu.
- 3 Select the calculation name.
- 4 Perform a distance measurement.
- 5 Save the measurement.

To return to the calculations menu, select **Calcs** on-screen.

## Percent reduction calculations

**WARNING:** To avoid incorrect calculations, verify that the patient information, date, and time settings are accurate.

To avoid misdiagnosis or harming the patient outcome, start a new patient information form before starting a new patient exam and performing calculations. Starting a new patient information form clears the previous patient’s data. The previous patient’s data will be combined with the current patient if the form is not first cleared. See “To create a new patient information form” on page 40.



Transducer	Exam Types
C11x	Abdomen, Vascular
C60x	Abdomen, Msk
HFL38x	IMT, Small Parts, Vascular
HFL50x	Msk, Small Parts
L25x	Msk, Vascular
L38x	IMT, Small Parts, Vascular
L38xi	IMT, Msk, Small Parts, Vascular
P10x	Abdomen
P21x	Abdomen
SLAx	Msk, Vascular

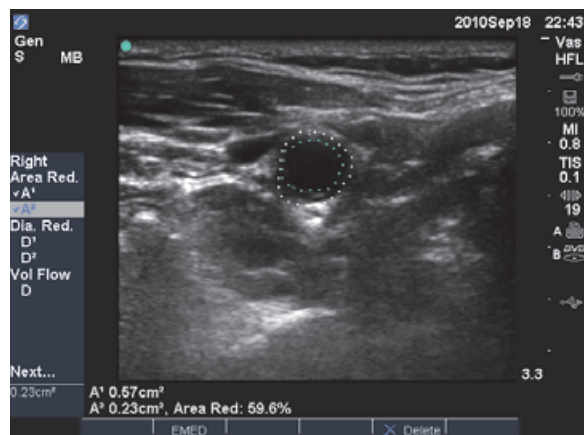

Figure 2 Percent area reduction calculation of right carotid bulb

### To calculate percent area reduction

The percent area reduction calculation involves two manual trace measurements.

- 1 On a frozen 2D image, press the CALCS key.
- 2 Do the following for **A<sup>1</sup>** and then for **A<sup>2</sup>**:

- a From the calculations menu, select the measurement name under **Area Red**.
- b Using the touchpad, move the caliper to the trace starting point, and press the SELECT key.
- c Using the touchpad, trace the desired area. To make a correction, select **Undo** on-screen or press the BACKSPACE key.
- d Complete the trace, and press the SET key.
- e Save the calculation. See [“To save a calculation”](#) on page 51.

The percent area reduction result appears on-screen in the measurement and calculation data area and in the patient report.

### To calculate percent diameter reduction

- 1 On a frozen 2D image, press the CALCS key.
- 2 Do the following for **D<sup>1</sup>** and then for **D<sup>2</sup>**:
  - a From the calculations menu, select the measurement name under **Dia Red**.
  - b Position the calipers. (See [“Working with calipers”](#) on page 47.)
  - c Save the calculation. See [“To save a calculation”](#) on page 51.

The percent diameter reduction result appears in the measurement and calculation data area and in the patient report.

## Volume calculations

**WARNING:** To avoid incorrect calculations, verify that the patient information, date, and time settings are accurate.

To avoid misdiagnosis or harming the patient outcome, start a new patient information form before starting a new patient exam and performing calculations. Starting a new patient information form clears the previous patient's data. The previous patient's data will be combined with the current patient if the form is not first cleared. See ["To create a new patient information form"](#) on page 40.

Transducer	Exam Types
C8x	Prostate
C11x	Abdomen, Neonatal, Nerve, Vascular,
C60x	Abdomen, Gyn, Msk, Nerve
HFL38x	Breast, Nerve, Small Parts, Vascular
HFL50x	Breast, Msk, Nerve, Small Parts
ICTx	Gyn
L25x	Msk, Nerve, Superficial, Vascular
L38x	Breast, Nerve, Small Parts, Vascular
L38xi	Breast, Msk, Nerve, Small Parts, Vascular
P10x	Abdomen, Neonatal
P21x	Abdomen

Transducer	Exam Types
SLAx	Msk, Nerve, Superficial, Vascular

### To calculate volume

The volume calculation involves three 2D distance measurements:  $D^1$ ,  $D^2$ , and  $D^3$ . After all measurements are saved, the result appears on-screen and in the patient report.

- ❖ Do the following for each image you need to measure:
  - a On the frozen 2D image, press the **CALCS** key.
  - b Do the following for each measurement you need to take:
    - i From the calculations menu, select the measurement name under **Volume**. (If **Volume** is not available in a Gyn exam, select **Gyn** and then select **Volume**.)
    - ii Position the calipers. (See ["Working with calipers"](#) on page 47.)
    - iii Save the measurement. See ["To save a calculation"](#) on page 51.

### Volume flow calculations

**WARNING:** To avoid incorrect calculations, verify that the patient information, date, and time settings are accurate.

To avoid misdiagnosis or harming the patient outcome, start a new patient information form before starting a new patient exam and performing calculations. Starting a new patient information form clears the previous patient's data. The previous patient's data will be combined with the current patient if the form is not first cleared. See ["To create a new patient information form"](#) on page 40.

Transducer	Exam Types
C11x	Abdomen, Vascular
C60x	Abdomen
HFL38x	Vascular
L25x	Vascular
L38x	Vascular
L38xi	Vascular
P10x	Abdomen
P21x	Abdomen
SLAx	Vascular

The following table shows the measurements required to complete the volume flow calculation. For definitions of acronyms, see “Glossary” on page 189.

### Volume Flow Calculations

Menu Heading	Measurement (Imaging Mode)	Calculation Result
Vol Flow	D (2D)* TAM or TAP (Doppler)	VF (Volume Flow ml/min)

\* Required if measuring the diameter instead of using the gate size

Both a 2D and a Doppler measurement are required for the volume flow calculation. For the 2D measurement, you can do either of the following:

- Measure the diameter of the vessel. This approach is more precise. The measurement overrides the gate size.
- Use the gate size. If you do not measure the diameter of the vessel, the system

automatically uses the gate size and “(gate)” appears in the calculation results.

The Doppler sample volume should completely insonate the vessel. You can measure either the time average mean or time average peak. To specify the live trace setting, see “Presets setup” on page 22.

Consider the following factors when performing volume flow measurements:

- Users should follow current medical practice for volume flow calculation applications.
- The accuracy of the volume flow calculation largely depends on the user.
- The factors identified in the literature that affect the accuracy are as follows:
  - Using the diameter method for 2D area
  - Difficulty ensuring uniform insonation of the vessel.

The system is limited to the following sample volume sizes:

- C11x transducer: 1, 2, 3 Gate Size (mm)
- C60x and P10x transducers: 2, 3, 5, 7, 10, 12 Gate Size (mm)
- HFL38x, L25x, and SLAx transducers: 1, 3, 5, 6, 7, 8, 10, 12 Gate Size (mm)
- L38x transducer: 1, 3, 5, 7, 10, 12 Gate Size (mm)
- P21x transducer: 2, 3, 5, 7, 11.5, 14 Gate Size (mm)
- Precision in placing the caliper
- Accuracy in angle correction

The considerations and degree of accuracy for volume flow measurements and calculations are discussed in the following references:

Allan, Paul L. et al. *Clinical Doppler Ultrasound*, 4th Ed., Harcourt Publishers Limited, (2000) 36-38.

## To calculate volume flow

- 1 If measuring the diameter instead of using the gate size, perform the 2D measurement:
  - a On a frozen full-screen 2D image or duplex image, press the CALCS key.
  - b From the calculations menu, select **D** (distance) under **Vol Flow**.
  - c Position the calipers. (See [“Working with calipers”](#) on page 47.)
  - d Save the calculation. See [“To save a calculation”](#) on page 51.
- 2 Perform the Doppler measurement:
  - a On a frozen Doppler spectral trace, press the CALCS key.
  - b From the calculations menu, select **TAM** or **TAP** under **Vol Flow**.  
A vertical caliper appears.
  - c Using the touchpad, position the vertical caliper at the beginning of the waveform.  
If calipers are not positioned correctly, the calculation result is inaccurate.
  - d Press the SELECT key to display a second vertical caliper.
  - e Using the touchpad, position the second vertical caliper at the end of the waveform.
  - f Press the SET key to complete the trace and to display the results.
  - g Save the calculation. See [“To save a calculation”](#) on page 51.

Results appear at the bottom of the screen as well as save to the patient report.

## Exam-based calculations

In addition to the general calculations, there are calculations specific to the Cardiac, Gynecology (Gyn), IMT, OB, Orbital, Small Parts, Transcranial Doppler (TCD), and Vascular exam types.

### Cardiac calculations

**WARNING:** To avoid incorrect calculations, verify that the patient information, date, and time settings are accurate.

To avoid misdiagnosis or harming the patient outcome, start a new patient information form before starting a new patient exam and performing calculations. Starting a new patient information form clears the previous patient's data. The previous patient's data will be combined with the current patient if the form is not first cleared. See [“To create a new patient information form”](#) on page 40.

Transducer	Exam Type
D2x	Cardiac
P10x	Cardiac
P21x	Cardiac
TEEx	Cardiac

The following table shows the measurements required to complete different cardiac calculations. For definitions of acronyms, see [“Glossary”](#) on page 189.

## Cardiac Calculations

Menu Heading	Cardiac Measurements (Imaging Mode)	Calculation Results
LV...LVd	RVW (2D)	CO
	RVD (2D)	EF
	IVS (2D)	SV
	LVD (2D)	LVESV
	LVPW (2D)	LVEDV
...LVs	RVW (2D)	IVSFT
	RVD (2D)	LVPWFT
	IVS (2D)	LVDFS
	LVD (2D)	CI
	LVPW (2D)	SI
	HR <sup>a</sup> needed for CO & CI	
Ao/LA	Ao (2D or M Mode)	Ao LA/Ao
	AAo (2D)	AAo
	LA (2D or M Mode)	LA LA/Ao
	LVOT D (2D)	LVOT D LVOT area
	ACS (M Mode)	ACS
	LVET (M Mode)	LVET
MV	EF:Slope (M Mode)	EF SLOPE
	EPSS (M Mode)	EPSS

Menu Heading	Cardiac Measurements (Imaging Mode)	Calculation Results
LV...LVd	RVW (M Mode)	CO
	RVD (M Mode)	EF
	IVS (M Mode)	SV
	LVD (M Mode)	LVESV
	LVPW (M Mode)	LVEDV
...LVs	RVW (M Mode)	IVSFT
	RVD (M Mode)	LVPWFT
	IVS (M Mode)	LVDFS
	LVD (M Mode)	CI
	LVPW (M Mode)	SI
		LV Mass
HR	HR <sup>a</sup>	
Area	AV (2D)	AV Area
	MV (2D)	MV Area
LV Vol (EF)	A4Cd (2D)	LV Vol
	A4Cs (2D)	LV Area
	A2Cd (2D)	EF
	A2Cs (2D)	CO
		SV
		CI
	SI	
	Biplane	
LV mass	Epi (2D)	LV Mass
	Endo (2D)	Epi Area
	Apical (2D)	Endo Area D Apical

Menu Heading	Cardiac Measurements (Imaging Mode)	Calculation Results	
PISA	Ann D (2D)	PISA Area	
	Radius (Color)	ERO	
	MR/VTI (Doppler)	MV Rate	
	MV/VTI (Doppler)	Regurgitant Volume Regurgitant Fraction	
Qp/Qs	LVOT D (2D)	D	
	RVOT D (2D)	VTI	
	LVOT VTI (Doppler)	VMax PGmax	
	RVOT VTI (Doppler)	Vmean PGmean SV Qp/Qs	
	CO	LVOT D (2D)	CO
		— (Doppler)	SV CI SI VTI HR LVOT D
TDI		(Wall) e' and a' (Doppler)	E(MV)/e' ratio
		(Wall) e' and a' (Doppler)	
		(Wall) e' and a' (Doppler)	
		(Wall) e' and a' (Doppler)	
		(Wall) 'e and a' (Doppler)	

Menu Heading	Cardiac Measurements (Imaging Mode)	Calculation Results	
P. Vein	A (Doppler)	VMax	
	Adur (Doppler)	time	
	S (Doppler)	VMax	
	D (Doppler)	S/D ratio	
MV	E (Doppler)	E	
	A (Doppler)	E PG A A PG E:A	
	Adur (Doppler)	time	
	PHT (Doppler)	PHT MVA Decel time	
	VTI (Doppler)	VTI Vmax PGmax Vmean PGmean	
	IVRT (Doppler)	time	
	MV...MR	dP:dT <sup>b</sup> (CW Doppler)	dP:dT

Menu Heading	Cardiac Measurements (Imaging Mode)	Calculation Results
AV	Vmax (Doppler)	Vmax PGmax
	VTI (Doppler)	VTI Vmax PGmax Vmean PGmean
	VTI or Vmax from LVOT (Doppler) VTI or Vmax from AV (Doppler)	AVA
Ao/LA	LVOT D (2D)	
AV	VTI (Doppler)	SV
Ao/LA	LVOT D (2D)	
AV	VTI (Doppler)	CO
Ao/LA	LVOT D (2D)	
HR	HR <sup>a</sup>	
LVOT	Vmax (Doppler)	Vmax PGmax
	VTI (Doppler)	VTI Vmax PGmax Vmean PGmean
AV...AI	PHT (slope) (Doppler)	AI PHT AI slope

Menu Heading	Cardiac Measurements (Imaging Mode)	Calculation Results
TV	TRmax (Doppler)	Vmax PGmax
	E (Doppler) A (Doppler)	E E PG A A PG E:A
	PHT (Doppler)	PHT MVA Decel time
	VTI (Doppler)	VTI Vmax PGmax Vmean PGmean
	RA pressure <sup>c</sup>	RVSP
	PV	Vmax (Doppler) VTI (Doppler) AT (Doppler)

- You can enter the HR measurement three ways: Patient information form, Doppler measurement (See [“To calculate Heart Rate \(HR\)”](#) on page 64), or M Mode measurement (See [“To measure heart rate \(M Mode\)”](#) on page 49).
- Performed at 100 cm/s and 300 cm/s.
- Specified on the cardiac patient report. See [“To delete a vascular or cardiac measurement”](#) on page 77.

## To measure LVd and LVs

- 1 On a frozen 2D image or M Mode trace, press the CALCS key.
- 2 From the calculations menu, select the measurement name.
- 3 Position the active (green) caliper at the starting point. (See “Working with calipers” on page 47.)
- 4 Press the SELECT key, and position the second caliper.
- 5 Press the SELECT key.

Another caliper appears, and the calculations menu highlights the next measurement name.

- 6 Position the caliper, and press the SELECT key. Repeat for each measurement name in the calculation group.

Each time you press the SELECT key, another caliper appears, and the calculations menu highlights the next measurement name.

- 7 Save the calculation. (See “To save a calculation” on page 51.)

## To measure Ao, LA, AAO, or LVOT D

- 1 On a frozen 2D image or M Mode trace, press the CALCS key.
- 2 From the calculations menu, select the measurement name.
- 3 Position the calipers. (See “Working with calipers” on page 47.)
- 4 Save the calculation. (See “To save a calculation” on page 51.)

## To calculate LV Volume (Simpson’s Rule)

- 1 On a frozen 2D image, press the CALCS key.
- 2 Do the following for each measurement:
  - a From the calculations menu, select the desired view and phase.
  - b Position the caliper at the mitral annulus, and press the SELECT key to start the trace.

- c Using the touchpad, trace the left ventricular (LV) cavity.

To make a correction, select **Undo** on-screen or press the BACKSPACE key.

- d Complete the trace, and press the SET key.
- e Save the calculation. (See “To save a calculation” on page 51.)

## To calculate MV or AV area

- 1 On a frozen 2D image, press the CALCS key.
- 2 In the calculations menu, locate **Area**, and then select **MV** or **AV**.
- 3 Position the caliper where you want to begin the trace, and press the SELECT key.

- 4 Using the touchpad, trace the desired area.

To make a correction, select **Undo** on-screen or press the BACKSPACE key.

- 5 Complete the trace, and press the SET key.
- 6 Save the calculation. (See “To save a calculation” on page 51.)

## To calculate LV Mass

- 1 On a frozen 2D image, press the CALCS key.
- 2 In the calculations menu, locate **LV Mass**.
- 3 Do the following for **EPI** and then for **Endo**:
  - a Select the measurement name from the calculations menu.
  - b Position the caliper where you want to begin the trace, and press the SELECT key.
  - c Using the touchpad, trace the desired area.

To make a correction, select **Undo** on-screen or press the BACKSPACE key.

- d Complete the trace, and press the SET key.
  - e Save the calculation. (See “To save a calculation” on page 51.).
- 4 Select **Apical** from the calculations menu.



- 5 Positioning the calipers, measure the ventricular length. (See “Working with calipers” on page 47.)
- 6 Save the calculation.

### To measure peak velocity

For each cardiac measurement, the system saves up to five individual measurements and calculates their average. If you take more than five measurements, the most recent measurement replaces the fifth one. If you delete a saved measurement from the patient report, the next measurement taken replaces the deleted one in the patient report. The most recently saved measurement appears at the bottom of the calculations menu.

- 1 On a frozen Doppler spectral trace, press the CALCS key.
- 2 From the calculations menu, select **MV**, **TV**, **TDI**, or **P. Vein**.
- 3 Do the following for each measurement you want to take:
  - a Select the measurement name from the calculations menu.
  - b Position the calipers. (See “Working with calipers” on page 47.)
  - c Save the calculation. (See “To save a calculation” on page 51.)

### To calculate Velocity Time Integral (VTI)

*Note: This calculation computes other results in addition to VTI. See the table “Cardiac Calculations” on page 57.*

- 1 On a frozen Doppler spectral trace, press the CALCS key.
- 2 From the calculations menu, select **VTI** under **MV**, **AV**, **TV**, **PV**, or **LVOT**.
- 3 Position the caliper at the start of the waveform, and press the SELECT key to start the trace.

- 4 Using the touchpad, trace the waveform.

To make a correction, select **Undo** on-screen, backtrack with the touchpad, or press the BACKSPACE key.

- 5 Press the SET key to complete the trace.
- 6 Save the calculation. (See “To save a calculation” on page 51.)

For information on the automatic trace tool, see “To trace automatically (Doppler)” on page 50.

### To calculate Right Ventricular Systolic Pressure (RVSP)

- 1 On a frozen Doppler spectral trace, press the CALCS key.
- 2 From the calculations menu, select **TV** and then select **TRmax**.
- 3 Position the caliper. (See “Working with calipers” on page 47.)
- 4 Save the calculation. (See “To save a calculation” on page 51.)
- 5 To adjust the RA pressure, see “To delete a vascular or cardiac measurement” on page 77.

Changing the RA pressure from the default 5 affects the RVSP calculation in the patient report.

### To calculate Pressure Half Time (PHT) in MV, AI, or TV

- 1 On a frozen Doppler spectral trace, press the CALCS key.
- 2 From the calculations menu, select **MV**, **AV**, or **TV**, and then select **PHT**.
- 3 Position the first caliper at the peak, and press the SELECT key.  
A second caliper appears.
- 4 Position the second caliper:
  - In MV, position the caliper along the EF slope.

- In AV, position the caliper at the end diastole.

5 Save the calculation. (See “[To save a calculation](#)” on page 51.)

### To calculate Proximal Isovelocity Surface Area (PISA)

The PISA calculation requires a measurement in 2D, a measurement in Color, and two measurements in Doppler spectral trace. After all measurements are saved, the result appears in the patient report.

- 1 Measure from Ann D (2D):
  - a On a frozen 2D image, press the CALCS key.
  - b From the calculations menu, locate **PISA**, and then select **Ann D**.
  - c Position the calipers. (See “[Working with calipers](#)” on page 47.)
  - d Save the calculation. (See “[To save a calculation](#)” on page 51.)
- 2 Measure from Radius (Color):
  - a On a frozen Color image, press the CALCS key.
  - b From the calculations menu, select **Radius**.
  - c Position the calipers.
  - d Save the calculation.
- 3 On a frozen Doppler spectral trace, press the CALCS key.
- 4 Do the following to measure from MR VTI and again to measure from MV VTI (Doppler):
  - a From the calculations menu, select **PISA** and then select **MR VTI** or **MV VTI**.
  - b Position the caliper at the start of the waveform, and press the SELECT key to start the trace.
  - c Using the touchpad, trace the waveform.

To make a correction, select **Undo** on-screen, backtrack with the touchpad, or press the BACKSPACE key.

- d Press the SET key to complete the trace.
- e Save the calculation.

For information on the automatic trace tool, see “[To trace automatically \(Doppler\)](#)” on page 50.

### To calculate Isovolumic Relaxation Time (IVRT)

- 1 On a frozen Doppler spectral trace, press the CALCS key.
- 2 From the calculations menu, select **MV** and then select **IVRT**.  
A vertical caliper appears.
- 3 Using the touchpad, position the caliper at the aortic valve closure.
- 4 Press the SELECT key.  
A second vertical caliper appears.
- 5 Using the touchpad, position the second caliper at onset of mitral inflow.
- 6 Save the calculation. (See “[To save a calculation](#)” on page 51.)

### To calculate Delta Pressure: Delta Time (dP:dT)

To perform the dP:dT measurements, the CW Doppler scale must include velocities of 300 cm/s or greater on the negative side of the baseline. (See “[Spectral trace options](#)” on page 32.)

- 1 On a frozen CW Doppler spectral trace, press the CALCS key.
- 2 From the calculations menu, select **MV**, and then select **dP:dT**.  
A horizontal dotted line with an active caliper appears at 100 cm/s.
- 3 Position the first caliper along the waveform at 100 cm/s.

- 4 Press the **SELECT** key.  
A second horizontal dotted line with an active caliper appears at 300 cm/s.
- 5 Position the second caliper along the waveform at 300 cm/s.
- 6 Save the calculation. (See [“To save a calculation”](#) on page 51.)

### To calculate Aortic Valve Area (AVA)

The AVA calculation requires a measurement in 2D and two measurements in Doppler. After the measurements are saved, the result appears in the patient report.

- 1 Measure from LVOT (2D):
  - a On a frozen 2D image, press the **CALCS** key.
  - b From the calculations menu, select **LVOT D**.
  - c Position the calipers. (See [“Working with calipers”](#) on page 47.)
  - d Save the calculation. (See [“To save a calculation”](#) on page 51.)
- 2 Measure from LVOT, and then measure from AV (Doppler):
  - For Vmax, see [“To measure peak velocity”](#) on page 61. From the calculations menu, select **AV**, select sample site, and then select **Vmax**.
  - For VTI, see [“To calculate Velocity Time Integral \(VTI\)”](#) on page 61. From the calculations menu, select **AV**, select sample site, and then select **VTI**.

### To calculate Qp/Qs

The Qp/Qs calculation requires two measurements in 2D and two measurements in Doppler. After the measurements are saved, the result appears in the patient report.

- 1 On a frozen 2D image, press the **CALCS** key.
- 2 Do the following to measure from LVOT D and again to measure from RVOT D:

- a From the calculations menu, locate **Qp/Qs** and then select **LVOT D** or **RVOT D**.
  - b Position the calipers. (See [“Working with calipers”](#) on page 47.)
  - c Save the calculation. (See [“To save a calculation”](#) on page 51.)
- 3 On a frozen Doppler spectral trace, press the **CALCS** key.
  - 4 Do the following to measure from LVOT VTI and again to measure from RVOT VTI:
    - a From the calculations menu, select **Qp/Qs** and then select **LVOT VTI** or **RVOT VTI**.
    - b Press the **SELECT** key to start the trace.
    - c Using the touchpad, trace the waveform.  
To make a correction, select **Undo** on-screen, backtrack with the touchpad, or press the **BACKSPACE** key.
    - d Press the **SET** key to complete the trace.
    - e Save the calculation. (See [“To save a calculation”](#) on page 51.)

For information on the automatic trace tool, see [“To trace automatically \(Doppler\)”](#) on page 50.

### To calculate Stroke Volume (SV) or Stroke Index (SI)

The SV and SI calculations require a measurement in 2D and a measurement in Doppler. SI also requires Body Surface Area (BSA). After the measurements are saved, the result appears in the patient report.

- 1 (SI Only) Fill in the **Height** and **Weight** fields on the patient information form. The BSA is calculated automatically. (See [“To create a new patient information form”](#) on page 40.)
- 2 Measure from LVOT (2D):
  - a On a frozen 2D image, press the **CALCS** key.
  - b From the calculations menu, select **LVOT D**.

- c Position the calipers. (See “Working with calipers” on page 47.)
  - d Save the calculation. (See “To save a calculation” on page 51.)
- 3 Measure from aorta (Doppler). See “To calculate Velocity Time Integral (VTI)” on page 61. From the calculations menu, select **AV** and then select **VTI**.

For information on the automatic trace tool, see “To trace automatically (Doppler)” on page 50.

### To calculate Heart Rate (HR)

Heart Rate is available in all cardiac packages. The Heart Rate is not calculated using the ECG trace.

Saving the heart rate to the patient report overwrites any heart rate entered on the patient information form.

- 1 On a frozen Doppler spectral trace, press the CALCS key.
- 2 From the calculations menu, select **HR**.  
A vertical caliper appears.
- 3 Using the touchpad, position the first vertical caliper at the peak of the heartbeat.
- 4 Press the SELECT key.

A second vertical caliper appears. The active caliper is highlighted green.

- 5 Using the touchpad, position the second vertical caliper at the peak of the next heartbeat.
- 6 Save the calculation. (See “To save a calculation” on page 51.)

### To calculate Cardiac Output (CO) or Cardiac Index (CI)

The CO and CI calculations require Stroke Volume and Heart Rate calculations. CI also requires Body Surface Area (BSA). After the measurements are saved, the result appears in the patient report.

- 1 (CI Only) Fill in the **Height** and **Weight** fields on the patient information form. The BSA is calculated automatically. (See “To create a new patient information form” on page 40.)
- 2 Calculate SV. See “To calculate Stroke Volume (SV) or Stroke Index (SI)” on page 63.
- 3 Calculate HR. See “To calculate Heart Rate (HR)” on page 64.

### To calculate Cardiac Output automatically

**WARNING:** To avoid incorrect calculation results, make sure that the Doppler signal does not alias.

**WARNING:** To avoid an incorrect diagnosis:

- Do not use automatic Cardiac Output calculations as the sole diagnostic criteria. Use them only in conjunction with other clinical information and patient history.
- Do not use automatic Cardiac Output calculations in neonatal patients.

To avoid inaccurate velocity measurements if you use PW Doppler, make sure that Angle Correction is set to zero.

The system can maintain the accuracy of automatic Cardiac Output measurements only if the flow rate is 1 L/min or greater.

- 1 Measure from LVOT (2D):
  - a On a frozen 2D image, press the CALCS key.
  - b From the calculations menu, select **CO**, and then select **LVOT D**.
  - c Position the calipers. (See “Working with calipers” on page 47.)
  - d Save the calculation. (See “To save a calculation” on page 51.)

## 2 Trace automatically (Doppler):

The automatic trace tool always measures the peak regardless of the Live Trace setting in Presets setup.

- a Display the Doppler spectral trace (waveform).
- b Select **Trace** on-screen, and then select **Above** or **Below** for the position of the automatic trace tool relative to the baseline.

The automatic trace tool appears in yellow.

The results appear at the bottom of the screen.

- c Freeze the image.

If you want to change the waveform measured, move each vertical caliper by pressing **SELECT** and then using the touchpad. Press **SET** to update the results.

If you invert the frozen image or move the baseline, results are cleared.

If you want to hide the results, select **Trace**.

- d Save the calculation.

## To measure a Tissue Doppler Imaging (TDI) waveform

- 1 Ensure that TDI is on. (See “PW Doppler options” on page 32.)
- 2 On a frozen Doppler spectral trace, press the **CALCS** key.
- 3 From the calculations menu, select **TDI**, and then do the following for each measurement you want to take:
  - a From the calculations menu, select the measurement name.
  - b Position the calipers. (See “Working with calipers” on page 47.)
  - c Save the calculation. (See “To save a calculation” on page 51.)

## Measurement publications and terminology (Cardiac)

The following are additional references for the Cardiac exam type.

### Left Ventricular Mass in gm for 2D

, N.B., P.M. Shah, M. Crawford, et.al.

“Recommendations for Quantification of the Left Ventricle by Two-Dimensional Echocardiography.” Journal of American Society of Echocardiography. September-October 1998, 2:364.

$$LV\ Mass = 1.05 * \{[(5/6) * A1 * (a + d + t)] - [(5/6) * A2 * (a + d)]\}$$

where:

A1 = Short axis area, diastole (Epi)

A2 = Short axis area, diastole (Endo)

a = Long or semi major axis

d = Truncated semi major axis from the widest short axis diameter to mitral annulus plane

t = Myocardial thickness

### Left Ventricular Mass in gm for M Mode

Oh, J.K., J.B. Seward, A.J. Tajik. *The Echo Manual*. 2nd Edition, Boston: Little, Brown and Company, (1999), 39.

$$LV\ Mass = 1.04 [(LVID + PWT + IVST)^3 - LVID^3] * 0.8 + 0.6$$

where:

LVID = Internal Dimension

PWT = Posterior Wall Thickness

IVST = Interventricular Septal Thickness

1.04 = Specific gravity of the myocardium

0.8 = Correction factor

## Gynecology (Gyn) calculations

Gynecology (Gyn) calculations include Uterus, Ovary, Follicle, and Volume. For instructions to calculate volume, see [“Volume calculations”](#) on page 54.

**WARNING:** To avoid incorrect calculations, verify that the patient information, date, and time settings are accurate.

To avoid misdiagnosis or harming the patient outcome, start a new patient information form before starting a new patient exam and performing calculations. Starting a new patient information form clears the previous patient’s data. The previous patient’s data will be combined with the current patient if the form is not first cleared. See [“To create a new patient information form”](#) on page 40.

---

Transducer	Exam Type
C60x	Gyn
ICTx	Gyn

---

### To measure uterus or ovary

- 1 On a frozen 2D image, press the CALCS key.
- 2 From the calculations menu, select **Gyn**.
- 3 Do the following for each measurement you want to take:
  - a Select the measurement name from the calculations menu.
  - b Position the calipers. (See [“Working with calipers”](#) on page 47.)
  - c Save the calculation. (See [“To save a calculation”](#) on page 51.)

## To measure follicles

On each side, you can save up to three distance measurements on a follicle, for up to 10 follicles.

If you measure a follicle twice, the average appears in the report. If you measure a follicle three times, the average and a volume calculation appear in the report.

- 1 On a frozen 2D image, press the CALCS key.
- 2 From the calculations menu, select **Follicle**.
- 3 Do the following for each measurement you want to take:
  - a From the calculations menu, select the follicle number under **Right Fol** or **Left Fol**.
  - b Position the calipers. (See “Working with calipers” on page 47.)
  - c Save the calculation. (See “To save a calculation” on page 51.)

## IMT calculations

**WARNING:** To ensure high quality images, all patient images must be obtained by qualified and trained individuals.

To avoid patient injury, IMT results should not be used as a sole diagnostic tool. All IMT results should be interpreted in conjunction with other clinical information or risk factors.

To avoid measurement errors, all measurements must be of the common carotid artery (CCA). This tool is not intended for measuring the bulb or the internal carotid artery (ICA).

**WARNING:** To avoid incorrect calculations, verify that the patient information, date, and time settings are accurate.

To avoid misdiagnosis or harming the patient outcome, start a new patient information form before starting a new patient exam and performing calculations. Starting a new patient information form clears the previous patient’s data. The previous patient’s data will be combined with the current patient if the form is not first cleared. See “To create a new patient information form” on page 40.

Transducer	Exam Type
L38x	IMT
L38xi	IMT
HFL38x	IMT

The following table shows available measurements for IMT calculations. The IMT measurement names are specified on the IMT setup page. See “IMT Calculations setup” on page 20.

## IMT Calculations (2D)





Menu Heading	Available Measurements
Right-IMT	Ant N (Anterior Near Wall)
Left-IMT	Ant F (Anterior Far Wall)
	Lat N (Lateral Near Wall)
	Lat F (Lateral Far Wall)
	Post N (Posterior Near Wall)
	Post F (Posterior Far Wall)
	IMT 1
	IMT 2
	IMT 3
	IMT 4
	IMT 5
	IMT 6
	IMT 7
	IMT 8
Plaque	Plaq 1
	Plaq 2

### To calculate IMT automatically

- 1 On a frozen 2D image, press the CALCS key.
- 2 From the calculations menu, select the measurement.
- 3 Using the touchpad or arrow keys, position the IMT tool over the area of interest until the measurement results appear.
- 4 Adjust the tool, and edit as needed. See “[IMT tool options](#)” on page 68.
- 5 Save the calculation. (See “[To save a calculation](#)” on page 51.)

## IMT tool options

When using the IMT tool, you can select the following options on-screen.

Option	Description
<b>Hide</b> 	Use to check results. Hides the measurement results and trace line. Select <b>Show</b> to redisplay them.
<b>Move</b> 	Repositions the tool horizontally by several pixels. The upper key moves the tool right, and the lower key moves the tool left.
<b>Width</b> 	Adjusts the tool width by 1 mm. The upper key increases the width, and the lower key decreases the width.
<b>Edit</b>	Displays <b>Smooth</b> , <b>Adven</b> , and <b>Lumen</b> .
<b>Smooth</b>	Adjusts the IMT line smoothing. Select <b>Edit</b> to display this option.
<b>Adven</b> 	Adjusts the adventitia-media line. The upper key moves the line upward. The lower key moves the line downward. Select <b>Edit</b> to display this option.
<b>Lumen</b> 	Adjusts the lumen-intima line. The upper key moves the line upward. The lower key moves the line downward. Each of the two IMT lines can be adjusted independently. Select <b>Edit</b> to display this option.



## To trace IMT manually

In manually tracing IMT, the user defines the location.

- 1 On a frozen 2D image, press the **CALCS** key
- 2 From the calculations menu, select a measurement name.
- 3 Select **Edit** on-screen, and then select **Manual**, and then select **Sketch**.

A single caliper appears, and *Trace* appears next to the measurement.

- 4 Do the following for the desired adventitia-media boundary and then for the lumen-intima boundary:
  - a Position the caliper at the beginning of the boundary, and press the **SELECT** key.
  - b Using the touchpad, mark points by moving the caliper to the next desired point and pressing the **SELECT** key.  
  
To make a correction, select **Undo** on-screen or press the **BACKSPACE** key to delete the last segment.
  - c Press the **SET** key to complete the trace line.
- 5 Save the calculation. (See [“To save a calculation”](#) on page 51.)

## To sketch IMT

The IMT sketch measurement involves two user-defined sketch lines that you can adjust manually.

- 1 On a frozen 2D image, press the **CALCS** key
- 2 From the calculations menu, select a measurement name.
- 3 Select **Edit** on-screen, and then select **Manual**.  
  
A single caliper appears on-screen, and *Sketch* appears next to the measurement.
- 4 Do the following for the desired adventitia-media boundary and then for the lumen-intima boundary:

- a Position the caliper at the beginning of the boundary and press the **SELECT** key.
- b Using the touchpad, mark points by moving the caliper to the next desired point and pressing the **SELECT** key.

To make a correction, select **Undo** on-screen or press the **BACKSPACE** key to delete the last segment.

- c Press the **SET** key to complete the trace line.
- d If necessary, adjust or edit the measurement. See [“IMT tool options”](#) on page 68.
- e Save the calculation. (See [“To save a calculation”](#) on page 51.)

## OB calculations

EFW is calculated only after appropriate measurements are completed. If any one of these parameters results in an EDD greater than what the OB calculation tables provide, the EFW is not displayed.

### WARNING:

Make sure that you have selected the OB exam type and the OB author for the OB calculation table you intend to use. See [“Results from System-Defined OB Measurements and Table Authors”](#) on page 70.

To avoid incorrect obstetrics calculations, verify with a local clock and calendar that the system's date and time settings are correct before each use of the system. The system does not automatically adjust for daylight savings time changes.

**WARNING:** To avoid misdiagnosis or harming the patient outcome, start a new patient information form before starting a new patient exam and performing calculations. Starting a new patient information form clears the previous patient's data. The previous patient's data will be combined with the current patient if the form is not first cleared. See ["To create a new patient information form"](#) on page 40.

Prior to use, verify that OB custom table data entries are correct. The system does not confirm the accuracy of the custom table data entered by the user.

Transducer	Exam Type
C60x	OB
ICTx	OB
P21x	OB

If you change the calculation author during the exam, the common measurements are retained.

The following table shows the system-defined measurements available for OB calculations by author. For definition of the acronyms, see ["Glossary"](#) on page 189. To select authors, see ["OB Calculations setup"](#) on page 20.

See also ["OB Custom Measurements setup"](#) on page 21 and ["OB Custom Tables setup"](#) on page 21.

## Results from System-Defined OB Measurements and Table Authors

Calculation Result	Gestational OB Measurements	Table Authors
Gestational Age <sup>a</sup>	YS	—
	GS	Hansmann, Nyberg, Tokyo U.
	CRL	Hadlock, Hansmann, Osaka, Tokyo U.
	BPD	Chitty, Hadlock, Hansmann, Osaka, Tokyo U.
	OFD	Hansmann
	HC	Chitty, Hadlock, Hansmann
	TTD	Hansmann, Tokyo U. <sup>b</sup>
	APTD	Tokyo U. <sup>b</sup>
	AC	Hadlock, Hansmann, Tokyo U.
	FTA	Osaka
	FL	Chitty, Hadlock, Hansmann, Osaka, Tokyo U.
	HL	Jeanty
	Tibia	Jeanty
	TCD	—
	CM	—
	Lat V	—
	CxLen	—

Calculation Result	Gestational OB Measurements	Table Authors
Estimated Fetal Weight (EFW) <sup>c</sup>	HC, AC, FL	Hadlock 1
	BPD, AC, FL	Hadlock 2
	AC, FL	Hadlock 3
	BPD, TTD	Hansmann
	BPD, FTA, FL	Osaka U.
	BPD, AC	Shepard
	BPD, TTD, APTD, FL	Tokyo U.
Ratios	HC/AC	Campbell
	FL/AC	Hadlock
	FL/BPD	Hohler
	FL/HC	Hadlock
Amniotic Fluid Index	Q <sup>1</sup> , Q <sup>2</sup> , Q <sup>3</sup> , Q <sup>4</sup>	Jeng
Growth Analysis Tables <sup>d</sup>	BPD	Chitty, Hadlock, Jeanty
	HC	Chitty, Hadlock, Jeanty
	AC	Chitty, Hadlock, Jeanty
	FL	Chitty, Hadlock, Jeanty
	EFW	Brenner, Hadlock, Jeanty
	HC/AC	Campbell

- The Gestational Age is automatically calculated and displayed next to the OB measurement you selected. The average of the results is the AUA.
- For Tokyo U., APTD and TTD are used only to calculate EFW. No age or growth tables are associated with these measurements.
- The Estimated Fetal Weight calculation uses an equation that consists of one or more fetal biometry measurements. The

author for the OB tables, which you choose on a system setup page, determines the measurements you must perform to obtain an EFW calculation. (See “OB Calculations setup” on page 20.)

Individual selections for Hadlock’s EFW equations 1, 2, and 3 are not determined by the user. The selected equation is determined by the measurements that have been saved to the patient report with priority given to the order listed above.

- The Growth Analysis tables are used by the Report Graphs feature. Three growth curves are drawn using the table data for the selected growth parameter and published author. Growth tables are only available with a user-entered LMP or Estab. DD.

## To measure gestational growth (2D)

For each 2D OB measurement (except AFI), the system saves up to three individual measurements and their average. If you take more than three measurements, the earliest measurement is deleted.

- In the patient information form, select **OB** exam type, and select **LMP** or **Estab.DD**. Select **Twins** if appropriate.
- On a frozen 2D image, press the **CALCS** key.
- Do the following for each measurement you want to take:
  - From the calculations menu, select the measurement name. For twins, select **Twin A** or **Twin B**, and then select the measurement name.

The caliper tool may change depending on the measurement selected, but the position remains constant.

- Position the calipers. (See “Working with calipers” on page 47.)
- Save the calculation. (See “To save a calculation” on page 51.)

## To measure fetal heart rate (M Mode)

- On a frozen M Mode trace, press the **CALCS** key.
- Select **FHR** from the calculations menu.

A vertical caliper appears.

- 3 Using the touchpad, position the vertical caliper at the peak of the heartbeat.
- 4 Press the SELECT key.  
A second vertical caliper appears.
- 5 Using the touchpad, position the second vertical caliper at the peak of the next heartbeat.
- 6 Save the calculation. (See “To save a calculation” on page 51.)

### OB Doppler Calculations

Menu Heading	OB Calculation	Results
MCA (Middle Cerebral Artery)	S/D, RI	SD RI
	S/D, RI, PI*	SD RI PI
Umb A (Umbilical Artery)	S/D, RI	SD RI
	S/D, RI, PI*	SD RI PI

\*Calculation requires a trace measurement.

### To calculate MCA or Umba (Doppler)

*Note: The system does not provide an MCA/UmbA ratio from the PI (Pulsatility Index).*

- 1 Select **OB** exam type, and select **LMP** or **Estab.DD** in the patient information form.
- 2 On a frozen Doppler spectral trace, press the CALCS key.
- 3 Do the following for each measurement you need to take:
  - a From the calculations menu, select the measurement name under **MCA** (Middle

Cerebral Artery) or **UmbA** (Umbilical Artery).

### b Position the calipers:

- For **S/D, RI**, position the first caliper at the peak systolic waveform. Press the SELECT key, and position the second caliper at the end diastole on the waveform.
- For **S/D, RI, PI**, position the caliper at the beginning of the desired waveform, and press the SELECT key. Use the touchpad to manually trace the desired area. Press the SET key.  
If calipers are not positioned correctly, the calculation result is inaccurate.

### c Save the calculation. (See “To save a calculation” on page 51.)

Only one calculation (**S/D, RI** or **S/D, RI, PI**) can be saved.

### Small Parts calculations

Small Parts calculations include volume, hip angle, and d:D ratio. For instructions to calculate volume, see “Volume calculations” on page 54.

Transducer	Exam Type
HFL38x	Small Parts
HFL50x	Small Parts
L38x	Small Parts
L38xi	Small Parts

### To calculate hip angle

- 1 On a frozen 2D image, press the CALCS key.
- 2 From the calculations menu, select **Right** or **Left**.
- 3 Select **Baseline** under **Hip Angle**.

A baseline appears on-screen.

- 4 Position the baseline, and press the SET key. (See “Working with calipers” on page 47.)

Line A (alpha line) appears on-screen, and **Line A** is selected in the calculations menu.

- 5 Position Line A, and save the measurement. (See “To save a calculation” on page 51.)

Line B (beta line) appears on-screen, and **Line B** is selected in the calculations menu.

- 6 Position Line B, and save the measurement.

### To calculate d:D ratio

- 1 On a frozen 2D image, press the CALCS key.
- 2 From the calculations menu, select **Right** or **Left**.
- 3 Under **d:D Ratio**, select **Fem Hd** (femoral head).
- 4 Using the touchpad, position and resize the circle. The SELECT key toggles between position and size.
- 5 Press the SET key.  
The baseline automatically appears with the left caliper active.
- 6 Position the caliper. (See “Working with calipers” on page 47.)
- 7 Save the measurement. (See “To save a calculation” on page 51.)

## Transcranial Doppler and Orbital calculations

**WARNING:** To avoid injury to the patient, use only an Orbital (Orb) exam type when performing imaging through the eye.

Verify that the patient information, date, and time settings are accurate.

To avoid carrying over measurements from the previous patient, start a new patient information form for each new patient before you perform calculations on the new patient. See “To create a new patient information form” on page 40.

Transducer	Exam Types
P21x	Transcranial (TCD), Orbital (Orb)

The following table shows the measurements required to complete Transcranial Doppler (TCD) and Orbital (Orb) calculations. For definitions of acronyms, see “Glossary” on page 189.

## Transcranial and Orbital Calculations

Menu Heading	TCD and Orb Measurements	Results
TT MCA	Dist Mid Prox  Bifur* ACA ACoA* TICA	TAP
		PSV
		EDV
		PI
		RI
		S/D
		Gate Size
TT	PCAp1 PCAp2 PCoA	
TO	OA Siphon	TAP
		PSV
		EDV
		PI
		RI
		S/D
	Gate Size	
SM	ECICA	TAP
		PSV
		EDV
		PI
		RI
		S/D
		Gate Size
FM BA	VA  Prox Mid Dist	TAP
		PSV
		EDV
		PI
		RI
		S/D
		Gate Size

AL	ECVA	TAP
		PSV
		EDV
		PI
		RI
		S/D
		Gate Size

\*Available but not required

**WARNING:** To avoid injury to the patient, use only an Orbital (Orb) or Ophthalmic (Oph) when performing imaging through the eye. The FDA has established lower acoustic energy limits for ophthalmic use. The system will not exceed these limits only if the Orbital or Ophthalmic exam type is selected.

### To perform a Transcranial Doppler or Orbital calculation

- Select the correct exam type:
  - Orbital (Orb)** to measure Ophthalmic Artery and Siphon
  - Transcranial (TCD)** for other measurements

See [“To change the exam type”](#) on page 34.
- On a frozen Doppler spectral trace, press the CALCS key.
- From the calculations menu, select **Left** or **Right**.
- Do the following for each measurement you want to take:
  - From the calculations menu, select the measurement. (You may need to select **Next** or **Prev** to locate the measurement.)
  - Do one of the following:

- For a manual trace measurement, use the touchpad to position the caliper. Press the SELECT key. Use the touchpad to trace the waveform.

If you need to make a correction, select **Undo** on-screen or press the BACKSPACE key.

- For an auto trace measurement, select **Auto** on-screen, and use the touchpad to position the first caliper at the beginning of the waveform. Press the SELECT key, and position the second caliper at the end of the waveform.

Confirm that the system-generated boundary is correct. If you are not satisfied with the trace, obtain a higher quality Doppler spectral trace image, or trace manually.

- c Press the SET key.
- d Save the calculation. (See [“To save a calculation”](#) on page 51.)

## Vascular calculations

**WARNING:** To avoid misdiagnosis or harming the patient outcome, start a new patient information form before starting a new patient exam and performing calculations. Starting a new patient information form clears the previous patient’s data. The previous patient’s data will be combined with the current patient if the form is not first cleared. See [“To create a new patient information form”](#) on page 40.

To avoid incorrect calculations, verify that the patient information, date, and time settings are accurate.

Transducer	Exam Type
C11x	Vascular
HFL38x	Vascular
L25x	Vascular
L38x	Vascular
L38xi	Vascular
SLAx	Vascular

The vascular measurements that you can save to the patient report are listed in the following table. For definitions of acronyms, see [“Glossary”](#) on page 189

## Vascular Calculations

Menu Heading	Vascular Measurement	Calculation Results
CCA	Prox	s (systolic), d (diastolic)
	Mid	s (systolic), d (diastolic)
	Dist	s (systolic), d (diastolic)
	Bulb	s (systolic), d (diastolic)
ICA	Prox	s (systolic), d (diastolic)
	Mid	s (systolic), d (diastolic)
	Dist	s (systolic), d (diastolic)
ECA	Prox	s (systolic), d (diastolic)
	Mid	s (systolic), d (diastolic)
	Dist	s (systolic), d (diastolic)
	VArty	s (systolic), d (diastolic)

### To perform a Vascular calculation

After you perform vascular measurements, values in the ICA/CCA ratios are selectable on the vascular page of the patient report.

- 1 On a frozen Doppler spectral trace, press the CALCS key.
- 2 From the calculations menu, select **Left** or **Right**.

- 3 Do the following for each measurement you want to take:
  - a From the calculations menu, select the measurement name.
  - b Using the touchpad, position the caliper at the peak systolic waveform.
  - c Press the SELECT key.  
A second caliper appears.
  - d Using the touchpad, position the second caliper at the end diastole on the waveform.
  - e Save the calculation. (See [“To save a calculation”](#) on page 51.)



## Calculations for L38xi transducer

Exam Type	Calculations
Bre	Volume
IMT	IMT Percent Reduction
Msk	Percent Reduction Volume
Nrv	Volume
SmP	Percent Reduction Small Parts Volume
Vas	Percent Reduction Vascular Volume Volume Flow

## Patient report

The patient report contains calculation results and patient information. For Cardiac, OB, Transcranial, and Vascular exams, the patient report has additional details and features.

You can display the patient report at any time during the exam.

The value for a calculation appears only if the calculation is performed. The pound symbol (###) indicates a value that is out of range (for example, too large or small). Calculation values that are out of range are not included in derived calculations (for example, mean).

### To display a patient report

- 1 Press the **REPORT** key.
- 2 Do any of the following:

- To display additional pages, select  **1/x** on-screen.
- (Cardiac, Vascular, or TCD) Select **Details** or **Summary** on-screen. The mean of the detail entries is used in the summary.

- 3 (Optional) Press the **SAVE** key to save the current page of the patient report.

To exit the patient report and return to imaging, select **Done**.

### To send a patient report to a PC

You can send a patient report to a PC as a text file.

- 1 Ensure correct configuration. See [“To configure the system for a DVD recorder, PC, or serial bar code scanner”](#) on page 19.

Make sure to use the connection cable supplied by SonoSite. Other connection cables may cause audio interference, including an inaudible Doppler signal.

- 2 Select **Send Rep.** on-screen.

## Vascular and cardiac patient reports

### To delete a vascular or cardiac measurement

- 1 On the **Details** page of the patient report, select the measurement by using the touchpad. (The selected measurement is green.)
- 2 Select **Delete** on-screen.

Deleting some measurements also deletes related measurements. Deleted measurements are not included in the summary information.

### (Vascular) To modify the ICA/CCA ratio

- ❖ In the **Ratio** list in the vascular patient report, select measurements for the ICA/CCA ratio for both the right and left sides.

## (Cardiac) To adjust the RA pressure

- ❖ On the **Summary** page of the cardiac patient report, select from the **RA** list.

Changing the RA pressure from the default 5 affects the RVSP calculation result.

## TCD patient report

The maximum values for the TAP calculation appear on the summary page.

### To delete a row of TCD measurements

- 1 On the **Details** page of the TCD patient report, select the row's TAP measurement using the touchpad. (The selected measurement is green.)
- 2 Select **Delete** on-screen.  
  
Deleted measurements are not included in the summary information.

## OB patient report

The OB patient report pages have a space for signing printed reports.

### To display the OB Twins patient report

- ❖ On the OB patient report, select one of the following on-screen:
  - **Twin A/B** for individual twin patient reports
  - **Compare** for both twins in one patient report

### To delete an OB measurement

- 1 On the OB patient report, select the OB measurement by using the touchpad.  
  
The selected measurement is green.
- 2 Select **Delete** on-screen.  
  
To delete all measurements, select the measurement label and press the **SELECT** key and then select **Delete** on-screen.

## To fill out the OB anatomy checklist

You can document reviewed anatomy.

- ❖ On the **Anatomy Checklist** page in the OB patient report, select the check boxes.  
  
Press the **TAB** key to move between fields and the **SPACEBAR** to select and deselect items in the checklist.

### To complete the OB biophysical profile

- ❖ On page 2 of the OB patient report, select values under **BPP**.  
  
The total is calculated when values are selected. NST (non-stress test) is optional.

### To display OB graphs

You can display OB graphs if the **LMP** or **Estab. DD** fields are complete in the patient information form.

- 1 On the OB patient report, select **Graphs** on-screen.
- 2 In the **Graphs** list, select the desired measurement/author.  
  
The graph for the selected measurement appears. You can select another measurement/author or select  **1/x** on-screen.  
  
For twins, both measurement sets are plotted on the same graph.
- 3 (Optional) Press the **SAVE** key to save the current graph page.
- 4 Select one of the following on-screen:
  - **Report** to return to the previous patient report page
  - **Done** to return to live imaging.

## EMED worksheets

EMED worksheets contain results from EMED calculations and checklists that you can complete.

## To display an EMED worksheet

This feature is optional.

- 1 After or during the exam, press the REPORT key.
- 2 Select **EMED** on-screen.
- 3 Select the worksheet from the **Worksheet** list or by selecting  **x/x** on-screen.

## MSK worksheets

MSK worksheets have lists from which you can select and a field for entering comments.

### To display an MSK worksheet

This feature is optional.

- 1 After or during the exam, press the REPORT key.
- 2 Select **MSK** on-screen.
- 3 Select the worksheet from the **Worksheet** list.

To display additional pages in the worksheet, select  **x/x** on-screen. Each worksheet has its own Comments field, which remains on-screen even if you display another page in the worksheet.

If you want to save a worksheet page, press the SAVE key.



# Chapter 5: Troubleshooting and Maintenance

This chapter contains information to help correct problems with system operation, to enter a software license, and to take proper care of the system, transducer, and accessories.

## Troubleshooting

If you encounter difficulty with the system, use the following list to help troubleshoot the problem. If the problem persists, contact SonoSite Technical Support. (See [“SonoSite Technical Support”](#) on page 7.)

**System does not turn on.** Check all power connections.

Remove the DC input connector and battery, wait 10 seconds, and then reinstall them.

Ensure that the battery is charged.

**System displays the alert “Incompatible power supply . . .”** Use the power supply that shipped with the system. See [“Compatible accessories and peripherals”](#) on page 106.

**System image quality is poor.** Adjust the display to improve viewing angle.

Adjust the brightness.

Adjust the gain.

**No CPD image.** Adjust the gain.

**No Color image.** Adjust the gain or the PRF scale.

**No OB measurement selections.** Select the OB exam type.

**System displays the alert “Maximum number of procedure entries reached” when trying to create a patient information form.** Free up internal-storage space by archiving or exporting patient exams and then deleting them from the system.

**System displays the alert “Unable to save image or clip. You have reached the maximum number of images/clips allowed for a single patient.”**

Delete any unwanted images or clips from the patient exam.

**Print does not work.** Select the printer on the Connectivity setup page. See [“To configure the system for a printer”](#) on page 19.

Check the printer connections.

Ensure that the printer is turned on and set up properly. See the printer manufacturer’s instructions, if necessary.

**DVD recorder does not record.** Check the DVD recorder connections.

Ensure that the DVD recorder is turned on and set up properly. See the applicable SonoSite accessory user guide and the manufacturers’ instructions.

**External monitor does not work.** Check the monitor connections. Check the monitor to ensure that it is turned on and set up properly. See the monitor manufacturers’ instructions, if necessary.

**System displays the alert “The external video is not functional . . .”** Make sure that the system is securely attached to the dock.

**System does not recognize the transducer.** Disconnect and reconnect the transducer.

**System prompts you to “ensure the USB device is valid.”** Make sure that the USB storage device does not have password protection enabled and is not defective. Use the USB storage device included with the system.

**System prompts you to “ensure the USB device contains valid data.”** Make sure that the data is present on the USB storage device.

Reexport the original data onto the USB storage device.

Contact your system administrator.

**A maintenance icon  appears on the system screen.** Restart the system. If the issue recurs, system maintenance may be required. Note the number that appears in parentheses on the C: line and contact SonoSite or your SonoSite representative. Software licensing

SonoSite software is controlled by a license key. After you install new software, the system prompts you for a license key. You must obtain one key for each system or transducer that uses the software.

The software will operate for a short time (the *grace period*) without a license key. During the grace period, all system functions are available. After the grace period, the system is not usable until you enter a valid license key. Grace period time is not used while the system is off or asleep. Grace period time remaining appears on the license update screen.

**Caution:** After the grace period expires, all system functions except licensing are unavailable until a valid license key is entered.

To obtain a license key for your software, contact SonoSite Technical Support. (See [“SonoSite Technical Support”](#) on page 7.) You need to provide the following information. (See [“System Information setup”](#) on page 23.)

System Software	Transducer Software
Name of person installing the upgrade	Name of person installing the upgrade
Serial number (on bottom of system)	Transducer serial number

System Software	Transducer Software
ARM version	Transducer part number (REF) or model number (for example, C60x)
PCBA serial number	Transducer bundle version

After you obtain a license key, you must enter it into the system.

### To enter a license key

- 1 Turn on the system.  
The license update screen appears.
- 2 Enter the license key in the **Enter license number** field.
- 3 Select **Done** on-screen.

If you entered a valid license key but the license update screen appears, verify that you entered the license key correctly. If the license update screen still appears, contact SonoSite Technical Support. (See [“SonoSite Technical Support”](#) on page 7.)

## Maintenance

Use the recommendations in this section when cleaning or disinfecting your ultrasound system, transducer, and accessories. Use the cleaning recommendations in the peripheral manufacturer’s instructions when cleaning or disinfecting your peripherals.

No periodic or preventive maintenance is required for the system, transducer, or accessories other than cleaning and disinfecting the transducer after every use. (See [“Cleaning and disinfecting transducers”](#) on page 84.) There are no internal components that require periodic testing or calibration. All maintenance requirements are described in this chapter and in the ultrasound system service manual.

Performing maintenance procedures not described in the user guide or service manual may void the product warranty.

**WARNING:** Do not modify the M-Turbo ultrasound system.

Contact SonoSite Technical Support for any maintenance questions. (See [“SonoSite Technical Support”](#) on page 7.)

**WARNING:** Disinfectants and cleaning methods listed are recommended by SonoSite for compatibility with product materials, not for biological effectiveness. Refer to the disinfectant label instructions for guidance on disinfection efficacy and appropriate clinical uses.

The level of disinfection required for a device is dictated by the type of tissue it contacts during use. To avoid infection, ensure that the disinfectant type and the solution strength and duration are appropriate for the equipment. For information, see the disinfectant label instructions and the recommendations of the Association for Professionals in Infection Control and Epidemiology (APIC) and the FDA.

**WARNING:** To prevent contamination, the use of sterile transducer sheaths and sterile coupling gel is recommended for clinical applications of an invasive or surgical nature. Do not apply the transducer sheath and gel until you are ready to perform the procedure.

**Caution:** Some transducer sheaths contain natural rubber latex and talc, which can cause allergic reactions in some individuals. Refer to 21 CFR 801.437, User labeling for devices that contain natural rubber.

## Cleaning and disinfecting the ultrasound system

The exterior surface of the ultrasound system and the accessories can be cleaned and disinfected using a recommended cleaner or disinfectant. See [“Recommended disinfectants”](#) on page 87.

**WARNING:** To avoid electrical shock, before cleaning, disconnect the system from the power supply or remove from the mini-dock or docking system.

To avoid infection always use protective eyewear and gloves when performing cleaning and disinfecting procedures.

To avoid infection, ensure that the solution expiration date has not passed.

**Caution:**

Do not spray cleaners or disinfectant directly on the system surfaces. Doing so may cause solution to leak into the system, damaging the system and voiding the warranty.

Do not use strong solvents such as thinner or benzene, or abrasive cleansers, since these will damage the exterior surfaces.

Use only recommended cleaners or disinfectants on system surfaces. Immersion-type disinfectants are not approved for use on system surfaces.

When you clean the system, ensure that the solution does not get inside the system controls or the battery compartment.

Do not scratch the LCD screen.

**To clean the LCD screen**

- ❖ Dampen a clean, non-abrasive, cotton cloth with an ethanolic-based cleaner, and wipe the screen clean.

Apply the cleaner to the cloth rather than the surface of the screen.

**To clean and disinfect system surfaces**

- 1 Turn off the system.
- 2 Disconnect the system from the power supply, or remove it from the mini-dock or docking system.
- 3 Clean the exterior surfaces using a soft cloth lightly dampened in a mild soap or detergent cleaning solution to remove any particulate matter or body fluids.  
  
Apply the solution to the cloth rather than the surface.
- 4 Mix the disinfectant solution compatible with the system, following disinfectant label

instructions for solution strengths and disinfectant contact duration.

- 5 Wipe surfaces with the disinfectant solution.
- 6 Air dry or towel dry with a clean cloth.

**Cleaning and disinfecting transducers**

To disinfect the transducer, use the immersion method or the wipe method. Follow the instructions on the disinfectant label.

See [Table 1, “Disinfectant Compatibility with System and Transducers”](#) on page 87.

**WARNING:**

To avoid electrical shock, before cleaning, disconnect the transducer from the system.

To avoid injury, always use protective eyewear and gloves when performing cleaning and disinfecting procedures.

To avoid infection, ensure that the solution expiration date has not passed.

**Caution:**

Transducers must be cleaned after every use. Cleaning transducers is necessary prior to effective disinfection. Ensure that you follow the manufacturer's instructions when using disinfectants.

Do not use a surgeon's brush when cleaning transducers. Even the use of soft brushes can damage a transducer. Use a soft cloth.

Using a non-recommended cleaning or disinfection solution, incorrect solution strength, or immersing a transducer deeper or for a longer period of time than recommended can damage or discolor the transducer and void the transducer warranty.



Do not allow cleaning solution or disinfectant into the transducer connector.

Do not allow disinfectant to contact metal surfaces. Use a soft cloth lightly dampened in a mild soap or compatible cleaning solution to remove any disinfectant that remains on metal surfaces.

Attempting to disinfect a transducer or transducer cable using a method other than the one included here can damage the transducer and void the warranty.

### **To clean and disinfect a transducer (wipe method)**

- 1 Disconnect the transducer from the system.
- 2 Remove any transducer sheath.
- 3 Clean the surface using a soft cloth lightly dampened in a mild soap or detergent cleaning solution to remove any particulate matter or body fluids.  
  
Apply the solution to the cloth rather than the surface.
- 4 Rinse with water or wipe with water-dampened cloth; then wipe with a dry cloth.
- 5 Mix the disinfectant solution compatible with the transducer, following disinfectant label instructions for solution strengths and disinfectant contact duration.
- 6 Wipe surfaces with the disinfectant solution.
- 7 Air dry.
- 8 Examine the transducer and cable for damage such as cracks, splitting, or fluid leaks.

If damage is evident, discontinue use of the transducer, and contact SonoSite or your local representative.

### **To clean and disinfect a transducer (immersion method)**

- 1 Disconnect the transducer from the system.
- 2 Remove any transducer sheath.
- 3 Clean the surface using a soft cloth lightly dampened in a mild soap or compatible cleaning solution to remove any particulate matter or body fluids.  
  
Apply the solution to the cloth rather than the surface.
- 4 Rinse with water or wipe with water-dampened cloth, and then wipe with a dry cloth.
- 5 Mix the disinfectant solution compatible with the transducer, following disinfectant label instructions for solution strengths and disinfectant contact duration.
- 6 Immerse the transducer into the disinfection solution not more than 12-18 inches (31-46 cm) from the point where the cable enters the connector.

Follow the instructions on the disinfectant label for the duration of the transducer immersion.

- 7 Using the instructions on the disinfectant label, rinse to the point of the previous immersion, and then air dry or towel dry with a clean cloth.
- 8 Examine the transducer and cable for damage such as cracks, splitting, or fluid leaks.

If damage is evident, discontinue use of the transducer, and contact SonoSite or your local representative.

## Cleaning and disinfecting the battery

**Caution:** To avoid damaging the battery, do not allow cleaning solution or disinfectant to come in contact with the battery terminals.

### To clean and disinfect a battery (wipe method)

- 1 Remove the battery from the system.
- 2 Clean the surface using a soft cloth lightly dampened in a mild soap or detergent cleaning solution.  
  
Apply the solution to the cloth rather than the surface.
- 3 Wipe the surfaces with the disinfection solution. Sani-Cloth HB, Sani-Cloth Wipes, or 70% isopropyl alcohol is recommended.
- 4 Air dry.

## Cleaning the footswitch

**Caution:** To avoid damaging the footswitch, do not sterilize. It is not intended for use in a sterile environment.

### To clean the footswitch

- 1 Dampen a non-abrasive cloth with one of the following products:
  - Isopropyl alcohol
  - Soap and water
  - Cidex
  - Sodium Hypochlorite 5.25% (Bleach) diluted 10:1
- 2 Wring out cloth until slightly wet and then gently rub soiled area until clean.

## Cleaning and disinfecting ECG cables

**Caution:** To avoid damaging the ECG cable, do not sterilize.

### To clean and disinfect the ECG cable (wipe method)

- 1 Remove the cable from the system.
- 2 Clean the surface using a soft cloth lightly dampened in a mild soap or detergent cleaning solution.  
  
Apply the solution to the cloth rather than the surface.
- 3 Wipe the surfaces with any of the following products:
  - Bleach (sodium hypochlorite)
  - Cidex disinfectants
  - Green soap
- 4 Air dry or towel dry with a clean cloth.

## Recommended disinfectants

Table 1 does not have the following regulatory information for disinfectants:

- EPA Registration
- FDA 510(k) clearance (liquid sterilant, high level disinfectant)
- CE approval

Before using a disinfectant, confirm that its regulatory status is appropriate for your jurisdiction and use. Verify expiration dates on chemicals.

When disposing of chemicals, follow manufacturer recommendations and EPA regulations.

**Table 1: Disinfectant Compatibility with System and Transducers**

Disinfection and Cleaning Solutions	Country of Origin	Type	Active Ingredient	C60x ICTx L38x P10x P21x SLAx	D2x	HFL38x	HFL50x	C11x/ L25x	System Surfaces
AbcoCide 14	USA	Liquid	Gluteraldehyde	✓	—	✓	—	✓	—
Accel Wipes	CAN	Wipe	Hydrogen Peroxide	✓	—	✓	—	✓	—
Aidal Plus	AUS	Liquid	Gluteraldehyde	✓	—	✓	—	✓	—
Alkacide	FRA	Liquid	Gluteraldehyde	✓	—	✓	—	✓	—
Alkazyme	FRA	Liquid	Quat. Ammonia	✓	—	✓	—	✓	—
Aquatabs (1000)	IRL	Tablet	Sodium Dichloroisocyanurate	✓	—	⊘	—	✓	—
Aquatabs (2000)	IRL	Tablet	Sodium Dichloroisocyanurate	✓	—	⊘	—	✓	—
Ascend	USA	Liquid	Quat Ammonia	✓	—	✓	—	✓	—
Asepti-HB	USA	Liquid	Quat Ammonia	✓	—	✓	✓	✓	—

**Table 1: Disinfectant Compatibility with System and Transducers (continued)**

Disinfection and Cleaning Solutions	Country of Origin	Type	Active Ingredient	C60x ICTx L38x P10x P21x SLAx	D2x	HFL38x	HFL50x	C11x/ L25x	System Surfaces
Asepti-Steryl	USA	Spray	Ethanol	✓	—	✓	—	✓	—
Asepti-Wipes	USA	Wipe	Propanol (Isopropyl Alcohol)	✓	—	✓	—	✓	✓
Bacillocid rasant	DEU	Liquid	Glut./Quat. Ammonia	✓	—	✓	—	✓	—
Bacoban	DEU	Liquid	Ethanol Isopropanol	✓	✓	—	—	—	—
Bacoban WB	DEU	Liquid	Benzalkoniumchloride Diethylenglycol	✓	✓	—	—	—	—
Banicide	USA	Liquid	Gluteraldehyde	✓	—	—	—	✓	—
Betadine	USA	Liquid	Providone-Iodine	⊗	—	⊗	—	✓	—
Bleach	USA	Liquid	NaCl Hypochlorite	✓	—	✓	—	✓	—
Cavicide	USA	Liquid	Isopropyl	✓	—	✓	—	✓	—
Caviwipes	USA	Wipes	Isopropanol	✓	—	✓	✓	⊗	✓
Chlor-Clean	GBR	Liquid	Sodium Dichloroisocyanurate	✓	—	⊗	—	✓	—
Cidex	USA	Liquid	Gluteraldehyde	✓	—	✓	—	✓	✓
Cidex OPA	USA	Liquid	Ortho-phthaldehyde	✓	✓	✓	✓	✓	—
Cidex Plus	USA	Liquid	Gluteraldehyde	✓	—	✓	—	✓	✓
Cleanisept	DEU	Wipes	Quat. Ammonia	✓	✓	✓	—	✓	✓
Clorox Wipes	USA	Wipes	Isopropanol	✓	—	✓	—	✓	—

**Table 1: Disinfectant Compatibility with System and Transducers (continued)**

Disinfection and Cleaning Solutions	Country of Origin	Type	Active Ingredient	C60x ICTx L38x P10x P21x SLAx	D2x	HFL38x	HFL50x	C11x/ L25x	System Surfaces
Control III	USA	Liquid	Quat. Ammonia	✓	—	✓	—	⊗	—
Coverage Spray	USA	Spray	Quat. Ammonia	✓	—	✓	—	⊗	⊗
DisCide Wipes	USA	Wipes	Isopropyl Alcohol	✓	—	✓	—	✓	⊗
DisOPA	JPN	Liquid	Ortho-phthaldehyde	✓	✓	✓	—	✓	✓
Dispatch	USA	Spray	NaCl Hypochlorite	✓	✓	✓	—	✓	—
Dynacide PA	FRA	Liquid	Peracetic Acid	—	✓	—	—	—	—
End-Bac II	USA	Liquid	Quat. Ammonia	✓	—	✓	—	✓	✓
Endosporine	FRA	Liquid	Gluteraldehyde	—	—	—	✓	—	—
Endozime AW Plus	FRA	Liquid	Propanol	✓	—	✓	—	✓	—
Envirocide	USA	Liquid	Isopropyl	✓	—	—	⊗	⊗	—
Enzol	USA	Cleaner	Ethylene Glycol	✓	—	✓	—	✓	—
Expose	USA	Liquid	Isopropyl	✓	—	✓	—	✓	—
Gigasept AF	DEU	Liquid	Quat. Ammonia	✓	—	✓	—	✓	—
Gluteraldehyde SDS	USA	Liquid	Gluteraldehyde	✓	—	—	—	✓	—
Hexanios	FRA	Liquid	Polyhexanide/Quat. Ammonia	✓	—	✓	—	✓	—
Hi Tor Plus	USA	Liquid	Chloride	✓	—	✓	—	⊗	—

**Table 1: Disinfectant Compatibility with System and Transducers (continued)**

Disinfection and Cleaning Solutions	Country of Origin	Type	Active Ingredient	C60x ICTx L38x P10x P21x SLAx	D2x	HFL38x	HFL50x	C11x/ L25x	System Surfaces
Hibiclens	USA	Cleaner	Chlorhexidine	✓	—	✓	—	✓	—
Hydrogen Peroxide	USA	Liquid	Hydrogen Peroxide	✓	✓	✓	✓	✓	✓
Kodan Tücher	DEU	Liquid	Propanol	✓	—	✓	—	✓	⊗
Kohrsolin ff	DEU	Liquid	Gluteraldehyde	✓	—	—	—	✓	—
Lem-O-Quat	USA	Liquid	Alkyl/Chloride	—	✓	—	—	—	—
LpHse	USA	Liquid	O-phenylphenol	✓	—	✓	—	✓	—
Lysol IC	USA	Liquid	O-phenylphenol	✓	—	⊗	—	✓	—
Madacide 1	USA	Liquid	Quaternary Ammonia	✓	⊗	✓	✓	⊗	⊗
Matar	USA	Liquid	O-phenylphenol	✓	—	—	—	✓	—
MetriCide 14	USA	Liquid	Gluteraldehyde	✓	—	✓	—	✓	—
MetriCide 28	USA	Liquid	Gluteraldehyde	✓	—	✓	—	✓	—
Metricide OPA Plus	USA	Liquid	Ortho-phthaldehyde	—	—	—	✓	—	—
MetriZyme	USA	Cleaner	Propylene Glycol	✓	—	✓	—	✓	—
Mikrobak forte	DEU	Liquid	Ammonium Chloride	✓	—	✓	—	✓	—
Mikrozid Wipes	DEU	Wipe	Ethanol/Propanol	✓	—	✓	—	✓	⊗
Nuclear	FRA	Spray	Alcohol/Biguanide	✓	—	✓	—	✓	—

**Table 1: Disinfectant Compatibility with System and Transducers (continued)**

Disinfection and Cleaning Solutions	Country of Origin	Type	Active Ingredient	C60x ICTx L38x P10x P21x SLAx	D2x	HFL38x	HFL50x	C11x/ L25x	System Surfaces
Reagent alcohol	n/a	Liquid	Denatured Ethyl Alcohol 3A	—	—	—	✓	—	—
Ruthless	USA	Spray	Quat. Ammonia	✓	—	✓	—	⊗	—
Sagrosept Wipe	DEU	Wipe	Propanol	✓	—	✓	—	✓	—
Salvanios pH 7	FRA	Liquid	Quat. Ammonia	✓	—	✓	—	✓	—
Sani-Cloth HB	USA	Wipe	Quat. Ammonia	✓	—	✓	✓	⊗	✓
Sani-Cloth Plus	USA	Wipe	Quat. Ammonia	✓	—	✓	✓	✓	✓
Sekusept	DEU	Liquid	Gluteraldehyde	—	✓	—	—	—	—
Sklar	USA	Liquid	Isopropanol	✓	—	✓	—	⊗	—
Sporicidin	USA	Liquid	Phenol	✓	⊗	✓	—	✓	—
Sporicidin Wipes	USA	Wipe	Phenol	✓	—	✓	—	✓	⊗
Staphene	USA	Spray	Ethanol	✓	—	⊗	—	✓	⊗
Steranios	FRA	Liquid	Gluteraldehyde	✓	—	✓	—	✓	—
Steranios 20%	FRA	Liquid	Gluteraldehyde	—	—	—	✓	—	—
T-Spray	USA	Spray	Quat. Ammonia	✓	—	✓	—	⊗	⊗
T-Spray II	USA	Spray	Alkyl/Chloride	✓	—	✓	—	✓	—
TASK 105	USA	Spray	Quat. Ammonia	✓	—	✓	—	✓	—

**Table 1: Disinfectant Compatibility with System and Transducers (continued)**

Disinfection and Cleaning Solutions	Country of Origin	Type	Active Ingredient	C60x ICTx L38x P10x P21x SLAx	D2x	HFL38x	HFL50x	C11x/ L25x	System Surfaces
TBQ	USA	Liquid	Alkyl	✓	—	✓	—	✓	—
Theracide Plus Wipes	USA	Wipe	Quat. Ammonia	✓	—	✓	—	✓	✓
Tor	USA	Liquid	Quat. Ammonia	✓	—	✓	—	⊙	—
Tristel	GBR	Liquid	Chlorine Dioxide	✓	✓	✓	—	✓	—
Tristel Solo	GBR	Foam	Hexamethylenebiguanide	—	✓	—	—	—	—
Tristel Wipes	GBR	Wipe	Chlorine Dioxide	⊙	✓	⊙	—	⊙	✓
Vesphene II	USA	Liquid	Sodium/ o-Phenylphenate	✓	—	✓	—	✓	—
Virex II 256	USA	Liquid	Ammonium Chloride	✓	—	✓	✓	✓	—
Virex TB	USA	Liquid	Quat. Ammonia	✓	—	✓	✓	⊙	⊙
Virox 5	CAN	Wipe	Hydrogen Peroxide	✓	✓	✓	—	✓	✓
Virufen	FRA	Liquid	Alkyl Ammonium Chloride	—	✓	—	—	—	—
Wavicide -06	USA	Liquid	Gluteraldehyde	✓	—	✓	—	✓	—
Wet Wipe Disinfection	DNK	Wipe	Guanidinium-chloride	—	✓	—	—	—	—
Wex-Cide	USA	Liquid	O-phenylphenol	✓	—	✓	—	✓	—



**Table 1: Disinfectant Compatibility with System and Transducers (continued)**

Disinfection and Cleaning Solutions	Country of Origin	Type	Active Ingredient	C60x	D2x	HFL38x	HFL50x	C11x/ L25x	System Surfaces
				ICTx					
				L38x					
				P10x					
				P21x					
				SLAx					
<p>✓ = Acceptable            ⊗ = Unacceptable. Do not use            — = Untested (Do not use)</p>									



This chapter contains information required by regulatory agencies, including information about the ALARA (as low as reasonably achievable) principle, the output display standard, acoustic power and intensity tables, and other safety information. The information applies to the ultrasound system, transducer, accessories, and peripherals.

## Ergonomic safety

These healthy scanning guidelines are intended to assist you in the comfort and effective use of your ultrasound system.

**WARNING:** To prevent musculoskeletal disorders, follow the guidelines in this section.

Use of an ultrasound system may be linked to musculoskeletal disorders (MSDs)<sup>a,b,c</sup>.

Use of an ultrasound system is defined as the physical interaction between the operator, the ultrasound system, and the transducer.

When using an ultrasound system, as with many similar physical activities, you may experience occasional discomfort in your hands, fingers, arms, shoulders, eyes, back, or other parts of your body. However, if you experience symptoms such as constant or recurring discomfort, pain, throbbing, aching, tingling, numbness, burning sensation, or stiffness, do not ignore these warning signs. Promptly see a qualified health professional. Symptoms such as these can be linked with MSDs. MSDs can be painful and may result in potentially disabling injuries to the nerves, muscles, tendons, or other parts of the body. Examples of MSDs include carpal tunnel syndrome and tendonitis.

While researchers are not able to definitively answer many questions about MSDs, there is a general agreement that certain factors are associated with their occurrence including preexisting medical and physical conditions, overall health, equipment and body position while doing work, frequency of work, duration of work, and other physical activities that may facilitate the onset of MSDs<sup>d</sup>. This chapter provides guidelines that may help you work more comfortably and may reduce your risk of MSDs<sup>e,f</sup>.

- a. Magnavita, N., L. Bevilacqua, P. Mirk, A. Fileni, and N. Castellino. "Work-related Musculoskeletal Complaints in Sonologists." *Occupational Environmental Medicine*. 41:11 (1999), 981-988.
- b. Craig, M. "Sonography: An Occupational Hazard?" *Journal of Diagnostic Medical Sonography*. 3 (1985), 121-125.
- c. Smith, C.S., G.W. Wolf, G. Y. Xie, and M. D. Smith. "Musculoskeletal Pain in Cardiac Ultrasonographers: Results of a Random Survey." *Journal of American Society of Echocardiography*. (May 1997), 357-362.
- d. Wihlidal, L.M. and S. Kumar. "An Injury Profile of Practicing Diagnostic Medical Sonographers in Alberta." *International Journal of Industrial Ergonomics*. 19 (1997), 205-216.
- e. Habes, D.J. and S. Baron. "Health Hazard Report 99-0093-2749." *University of Medicine and Dentistry of New Jersey*. (1999).
- f. Vanderpool, H.E., E.A. Friis, B.S. Smith, and K.L. Harms. "Prevalence of Carpal Tunnel Syndrome and Other Work-related Musculoskeletal Problems in Cardiac Sonographers." *Journal of Medicine*. 35:6 (1993), 605-610.

## Position the system

### Promote comfortable shoulder, arm, and hand postures

- Use a stand to support the weight of the ultrasound system.

### Minimize eye and neck strain

- If possible, position the system within reach.
- Adjust the angle of the system and display to minimize glare.
- If using a stand, adjust its height so that the display is at or slightly below eye level.

## Position yourself

### Support your back during an exam

- Use a chair that supports your lower back, that adjusts to your work surface height, that promotes a natural body posture, and that allows quick height adjustments.
- Always sit or stand upright. Avoid bending or stooping.

### Minimize reaching and twisting

- Use a bed that is height adjustable.
- Position the patient as close to you as possible.
- Face forward. Avoid twisting your head or body.
- Move your entire body front to back, and position your scanning arm next to or slightly in front of you.
- Stand for difficult exams to minimize reaching.
- Position the ultrasound system or display directly in front of you.
- Provide an auxiliary monitor for patient viewing.

### Promote comfortable shoulder and arm postures

- Keep your elbow close to your side.
- Relax your shoulders in a level position.
- Support your arm using a support cushion or pillow, or rest it on the bed.

## Promote comfortable hand, wrist, and finger postures

- Hold the transducer lightly in your fingers.
- Minimize the pressure applied on the patient.
- Keep your wrist in a straight position.

## Take breaks, exercise, and vary activities

- Minimizing scanning time and taking breaks can effectively allow your body to recover from physical activity and help you avoid MSDs. Some ultrasound tasks may require longer or more frequent breaks. However, simply changing tasks can help some muscle groups relax while others remain or become active.
- Work efficiently by using the software and hardware features correctly.
- Keep moving. Avoid sustaining the same posture by varying your head, neck, body, arm, and leg positions.
- Do targeted exercises. Targeted exercises can strengthen muscle groups, which may help you avoid MSDs. Contact a qualified health professional to determine stretches and exercises that are right for you.

## Electrical safety classification

### Class I equipment

The ultrasound system is classified as Class I equipment when powered from the external power supply or mounted on the stand because the external power supply is a Class 1 protectively earthed power supply.

The stand has no protective earth. Ground bond testing is not applicable to the ultrasound system or the stand.

*Note: AC powered peripherals that may be used with the system are Class I and are individually protectively earthed. Ground bond testing may be conducted on each AC powered peripheral.*

### Internally powered equipment

Ultrasound system not connected to the power supply (battery only)

### Type BF applied parts

Ultrasound transducers

### Type CF applied parts

ECG module/ECG leads

### IPX-7 (watertight equipment)

Ultrasound transducers

### IPX-8 (watertight equipment)

Footswitch

### Non AP/APG

Ultrasound system power supply, docking system, and peripherals. Equipment is not suitable for use in the presence of flammable anaesthetics.

## Electrical safety

This system meets EN60601-1, Class I/internally-powered equipment requirements and Type BF and Type CF isolated patient-applied parts safety requirements.

This system complies with the applicable medical equipment requirements published in the Canadian Standards Association (CSA), European Norm Harmonized Standards, and Underwriters Laboratories (UL) safety standards. See [Chapter 8, “Specifications.”](#)

For maximum safety observe the following warnings and cautions.

**WARNING:**

To avoid discomfort or minor risk of patient injury, keep hot surfaces away from the patient.

Under certain circumstances, the transducer connector and back of the display enclosure can reach temperatures that exceed EN60601-1 limits for patient contact, therefore only the operator shall handle the system. This does not include the transducer face.

To avoid discomfort or minor risk of operator injury when handling the transducer connector, the system should not be operated for more than 60 minutes continuously in a live-scan mode (as opposed to freeze or sleep modes).

To avoid the risk of injury, do not operate the system in the presence of flammable gasses or anesthetics. Explosion can result.

To avoid the risk of electrical shock or injury, do not open the system enclosures. All internal adjustments and replacements, except battery replacement, must be made by a qualified technician.

To avoid the risk of electrical shock, do not allow any part of the system (including the bar code scanner, external mouse, power supply, power supply connector, external keyboard, and so on), except for the transducer or ECG leads, to touch the patient.

To avoid the risk of electrical shock:

- This equipment must be connected only to a supply mains with protective earth.
- Do not let the bar code scanner or external mouse touch the patient.
- Do not let the power supply or connector touch the patient.
- Do not touch the power supply and the patient at the same time.
- Use only properly grounded equipment. Shock hazards exist if the power supply is not properly grounded. Grounding reliability can only be achieved when equipment is connected to a receptacle marked “Hospital Only” or “Hospital Grade” or the equivalent. The grounding wire must not be removed or defeated.
- When using the system in an environment where the integrity of the protective earth conductor arrangement is in doubt, operate the system on battery power only without using the power supply.
- Do not touch any of the following:
  - The ungrounded signal input/output connectors on the back of the ultrasound system.
  - The system battery contacts (inside the battery compartment).
  - The system transducer connector when the transducer or Triple Transducer Connect (TTC) is disconnected.
  - The system transducer connector on the triple transducer connector if no transducers are connected.
- Do not connect the system’s power supply or a docking system to an MPSO or extension cord.
- Before using the transducer, inspect the transducer face, housing, and cable. Do not use the transducer if the transducer or cable is damaged.
- Always disconnect the power supply from the system before cleaning the system.
- Do not use any transducer that has been immersed beyond the specified cleaning or disinfection level. See [Chapter 5, “Troubleshooting and Maintenance.”](#)
- Use only accessories and peripherals recommended by SonoSite, including the power supply. Connection of accessories and peripherals not recommended by SonoSite could result in electrical shock. Contact SonoSite or your local representative for a list of accessories and peripherals available from or recommend by SonoSite.
- Use commercial grade peripherals recommended by SonoSite on battery power only. Do not connect these products to AC mains power when using the system to scan or diagnose a patient/subject. Contact SonoSite or your local representative for a list of the commercial grade peripherals available from or recommended by SonoSite.

To avoid the risk of electrical shock and fire hazard:

- Inspect the power supply, AC power cords, cables, and plugs on a regular basis. Ensure that they are not damaged.
- The power cord set that connects the power supply of the ultrasound system or MDS to mains power must only be used with the power supply or docking system, and cannot be used to connect other devices to mains power.

To prevent injury to the operator/bystander, the transducer must be removed from patient contact before the application of a high-voltage defibrillation pulse.

To avoid possible electrical shock or electromagnetic interference, verify proper operation and compliance with relevant safety standards for all equipment before clinical use. Connecting additional equipment to the ultrasound system constitutes configuring a medical system. SonoSite recommends verifying that the system, all combinations of equipment, and accessories connected to the ultrasound system comply with JACHO installation requirements and/or safety standards such as AAMI-ES1, NFPA 99 OR IEC Standard 60601-1-1 and standard IEC 60601-1-2 (), and are certified according to IEC Standard 60950 (Information Technology Equipment (ITE)).

**Caution:**

Do not use the system if an error message appears on the image display: note the error code; call SonoSite or your local representative; turn off the system by pressing and holding the power key until the system powers down.

To avoid increasing the system and transducer connector temperature, do not block the airflow to the ventilation holes on the side of the system.

## Equipment safety

To protect your ultrasound system, transducer, and accessories, follow these precautions.

**Caution:**

Excessive bending or twisting of cables can cause a failure or intermittent operation.

Improper cleaning or disinfecting of any part of the system can cause permanent damage. For cleaning and disinfecting instructions, see [Chapter 5, "Troubleshooting and Maintenance."](#)

Do not submerge the transducer connector in solution. The cable is not liquid-tight beyond the transducer connector/cable interface.

Do not use solvents such as thinner or benzene, or abrasive cleaners on any part of the system.



Remove the battery from the system if the system is not likely to be used for some time.

Do not spill liquid on the system.

## Battery safety

To prevent the battery from bursting, igniting, or emitting fumes and causing personal injury or equipment damage, observe the following precautions.

**WARNING:** Periodically, check to make sure that the battery charges fully. If the battery fails to charge fully, replace it.

Do not ship a damaged battery without instructions from SonoSite Technical Support.

Do not short-circuit the battery by directly connecting the positive and negative terminals with metal objects.

Do not touch battery contacts.

Do not heat the battery or discard it in a fire.

Do not expose the battery to temperatures over 60°C (140°F). Keep it away from fire and other heat sources.

Do not charge the battery near a heat source, such as a fire or heater.

Do not leave the battery in direct sunlight.

Do not pierce the battery with a sharp object, hit it, or step on it.

Do not use a damaged battery.

Do not solder a battery.

The polarity of the battery terminals are fixed and cannot be switched or reversed. Do not force the battery into the system.

Do not connect the battery to an electrical power outlet.

Do not continue recharging the battery if it does not recharge after two successive six hour charging cycles.

If the battery leaks or emits an odor, remove it from all possible flammable sources.

**Caution:** To avoid the battery becoming damaged and causing equipment damage, observe the following precautions:

- Do not immerse the battery in water or allow it to get wet.
- Do not put the battery into a microwave oven or pressurized container.

- If the battery emits an odor or heat, is deformed or discolored, or in any way appears abnormal during use, recharging or storage, immediately remove it and stop using it. If you have any questions about the battery, consult SonoSite or your local representative.
- Store the battery between -20°C (-4°F) and 60°C (140°F).
- Use only SonoSite batteries.
- Do not use or charge the battery with non-SonoSite equipment. Only charge the battery with the system.

## Clinical safety

### **WARNING:**

Non-medical (commercial) grade peripheral monitors have not been verified or validated by SonoSite as being suitable for diagnosis.

To avoid the risk of a burn hazard, do not use the transducer with high frequency surgical equipment. Such a hazard may occur in the event of a defect in the high frequency surgical neutral electrode connection.

Do not use the system if it exhibits erratic or inconsistent behavior. Discontinuities in the scanning sequence are indicative of a hardware failure that must be corrected before use.

Some transducer sheaths contain natural rubber latex and talc, which can cause allergic reactions in some individuals. Refer to 21 CFR 801.437, User labeling for devices that contain natural rubber.

Perform ultrasound procedures prudently. Use the ALARA (as low as reasonably achievable) principle and follow the prudent use information concerning MI and TI.

SonoSite does not currently recommend a specific brand of acoustic standoff. If an acoustic standoff is used, it must have a minimum attenuation of .3dB/cm/MHz.

Some SonoSite transducers are approved for intraoperative applications if a market-cleared sheath is used.

To avoid injury or reduce the risk of infection to the patient, observe the following:

- Follow Universal Precautions when inserting and maintaining a medical device for interventional and intraoperative procedures.
- Appropriate training in Interventional and Intraoperative procedures as dictated by current relevant medical practices as well as in proper operation of the ultrasound system and transducer is required. During vascular access, the potential exists for serious complications including without limitation the following: pneumothorax, arterial puncture, guide-wire misplacement, and risks normally associated with local or general anesthesia, surgery, and post-operative recovery.

To avoid device damage or patient injury, do not use the P10x, P17x, or P21x needle guide bracket on patients with pacemakers or medical electronic implants. The needle guide bracket for the P10x, P17x, and P21x transducers contains a magnet that is used to ensure the bracket is correctly oriented on the transducer. The magnetic field in direct proximity to the pacemaker or medical electronic implant may have an adverse effect.

## Hazardous materials

- WARNING:** Products and accessories may contain hazardous materials. Ensure that products and accessories are disposed of in an environmentally responsible manner and meet federal and local regulations for disposing hazardous materials.
- WARNING:** The liquid crystal display (LCD) contains mercury. Dispose of the LCD properly in accordance with local regulations.

## Electromagnetic compatibility

The ultrasound system has been tested and found to comply with the electromagnetic compatibility (EMC) limits for medical devices to IEC 60601-1-2:2001. These limits are designed to provide reasonable protection against harmful interference in a typical medical installation.

- WARNING:** The M-Turbo ultrasound system should not be used adjacent to or stacked with other equipment. If such use occurs, verify that the M-Turbo ultrasound system operates normally in that configuration.
- Caution:** Medical electrical equipment requires special precautions regarding EMC and must be installed and operated according to these instructions. It is possible that high levels of radiated or conducted radio-frequency electromagnetic interference (EMI) from portable and mobile RF communications equipment or other strong or nearby radio-frequency sources, could result in performance disruption of the ultrasound system. Evidence of disruption may include image degradation or distortion, erratic readings, equipment ceasing to operate, or other incorrect functioning. If this occurs, survey the site to determine the source of disruption, and take the following actions to eliminate the source(s).
- Turn equipment in the vicinity off and on to isolate disruptive equipment.
  - Relocate or re-orient interfering equipment.
  - Increase distance between interfering equipment and your ultrasound system.
  - Manage use of frequencies close to ultrasound system frequencies.
  - Remove devices that are highly susceptible to EMI.
  - Lower power from internal sources within facility control (such as paging systems).
  - Label devices susceptible to EMI.
  - Educate clinical staff to recognize potential EMI-related problems.
  - Eliminate or reduce EMI with technical solutions (such as shielding).
  - Restrict use of personal communicators (cell phones, computers) in areas with devices susceptible to EMI.
  - Share relevant EMI information with others, particularly when evaluating new equipment purchases which may generate EMI.
  - Purchase medical devices that comply with IEC 60601-1-2 EMC Standards.

**Caution:**

To avoid the risk of increased electromagnetic emissions or decreased immunity, use only accessories and peripherals recommended by FUJIFILM SonoSite. Connection of accessories and peripherals not recommended by FUJIFILM SonoSite to the ultrasound system may result in malfunction of the ultrasound system or other medical electrical devices in the area. Contact FUJIFILM SonoSite or your local representative for a list of accessories and peripherals available from or recommended by FUJIFILM SonoSite. See the FUJIFILM SonoSite accessories user guide.

Electrostatic discharge (ESD), or static shock, is a naturally occurring phenomenon. ESD is common in conditions of low humidity, which can be caused by heating or air conditioning. ESD is a discharge of the electrical energy from a charged body to a lesser or non-charged body. The degree of discharge can be significant enough to cause damage to a transducer or an ultrasound system. The following precautions can help reduce ESD: anti-static spray on carpets, anti-static spray on linoleum, and anti-static mats.

## Separation distance

### Recommended separation distances between portable and mobile RF communications equipment and the M-Turbo ultrasound system

The M-Turbo ultrasound system is intended for use in an electromagnetic environment in which radiated radio frequency (RF) disturbances are controlled. The customer or the user of the M-Turbo ultrasound system can help prevent electromagnetic interference by maintaining a minimum distance between portable and mobile RF communications equipment (transmitters) and the M-Turbo ultrasound system as recommended below, according to the maximum output power of the communications equipment.

Rated maximum output power of transmitter <i>Watts</i>	Separation distance according to frequency of transmitter m		
	150 kHz to 80 MHz $d=1.2 \sqrt{P}$	80 MHz to 800 MHz $d=1.2 \sqrt{P}$	800 MHz to 2.5 GHz $d=2.3 \sqrt{P}$
0.01	0.12	0.12	0.23
0.1	0.38	0.38	0.73
1	1.2	1.2	2.3
10	3.8	3.8	7.3
100	12	12	23

For transmitters rated at a maximum output power not listed above, the recommended separation distance (d) in meters (m) can be estimated using the equation applicable to the frequency of the transmitter, where  $P$  is the maximum output power rating of the transmitter in watts (W) according to the transmitter manufacturer.

*Note: At 80 MHz and 800 MHz, the separation distance for the higher frequency range applies. These guidelines may not apply in all situations. Electromagnetic propagation is affected by absorption and reflection from structures, objects, and people.*

## Compatible accessories and peripherals

FUJIFILM SonoSite has tested the M-Turbo ultrasound system with the following accessories and peripherals and has demonstrated compliance to the requirements of IEC60601-1-2:2007.

You may use these FUJIFILM SonoSite accessories and third-party peripherals with the M-Turbo ultrasound system.

- WARNING:** Use of the accessories with medical systems other than the M-Turbo ultrasound system may result in increased emissions or decreased immunity of the medical system.
- WARNING:** Use of accessories other than those specified may result in increased emissions or decreased immunity of the ultrasound system.

### Accessories and peripherals compatible with M-Turbo ultrasound system

Description	Maximum Cable Length
C11x transducer <sup>a</sup>	6.0 ft/1.8 m
C60x transducer <sup>a</sup>	5.5 ft/1.7 m
D2x transducer <sup>a</sup>	5.5 ft/1.7 m
HFL38x transducer <sup>a</sup>	5.5 ft/1.7 m
HFL50x transducer <sup>a</sup>	5.7 ft/1.7 m
ICTx transducer <sup>a</sup>	5.5 ft/1.7 m
L25x transducer <sup>a</sup>	7.5 ft/2.3 m
L38x transducer <sup>a</sup>	5.5 ft/1.7 m
L38xi transducer <sup>a</sup>	5.5 ft/1.7 m
L52x transducer <sup>a</sup>	7.9 ft/2.4 m
P10x transducer <sup>a</sup>	6.0 ft/1.8 m
P21x transducer <sup>a</sup>	6.0 ft/1.8 m
SLAx transducer <sup>a</sup>	7.5 ft/2.3 m
TEEx transducer <sup>a</sup>	11.8 ft/3.6 m
Bar code scanner	4.8 ft/1.5 m
Battery for PowerPack	—
Battery Pack	—
Battery PowerPack	—
Black & white printer	—
Black & white printer cable	3.3 ft/1 m

## Accessories and peripherals compatible with M-Turbo ultrasound system (Continued)

Black & white printer USB cable	10.8 ft/3.3 m
Color printer	—
Color printer power cable	3.3 ft/1 m
Color printer video cable	6.0 ft/ 1.8 m
ECG lead wires	24 in/ 0.6 m
ECG module	5.8 ft/1.8 m
Footswitch	9.8 ft/3.0 m
H-Universal Stand	—
M-Turbo Dock	—
Petite mouse	6 ft /1.8 m
Power cord (system)	10 ft/3 m
Power supply with DC cable	6.8 ft/ 2 m
Power supply AC cable	39 in/ 1 m
PowerPark	—
Triple Transducer Connect	—
USB keyboard	—
USB wireless adapter	—

a For transducers, the maximum cable length is measured between the strain reliefs. The stated length do not include the lengths of cable in the following locations: underneath the strain reliefs, inside the transducer enclosure, and inside the transducer connector.

## Guidance and manufacturer's declaration

**WARNING:** Other equipment, even equipment that complies with CISPR emission requirements, can interfere with the M-Turbo ultrasound system.

The M-Turbo ultrasound system contains an IEEE 802.11 receiver and transmitter that utilizes the ISM frequency band from 2.412 to 2.4835 GHz and implements three methods of transmission:

- IEEE 802.11b with Complementary Code Keying (CCK), Differential Quaternary Phase Shift Keying (DQPSK), and Differential Binary Phase Shift Keying (DBPSK) at 17 dBm



- IEEE 802.11g with Orthogonal Frequency Division Multiplexing (OFDM) at 14 dBm
- IEEE 802.11n with OFDM at 14 dBm

.

## Guidance and Manufacturer's Declaration - Electromagnetic Immunity

The M-Turbo ultrasound system is intended for use in the electromagnetic environment specified below. The customer or the user of the M-Turbo ultrasound system should assure that it is used in such an environment.

Immunity Test	IEC 60601 Test Level	Compliance Level	Electromagnetic Environment
Electrostatic Discharge (ESD) IEC 61000-4-2	±6.0KV contact ±8.0KV air	±6.0KV contact ±8.0KV air	Floors should be wood, concrete, or ceramic tile. If floors are covered with synthetic material, the relative humidity should be at least 30%.
Electrical fast Transient burst IEC 61000-4-4	±2KV for power supply lines ±1KV for input/output lines	±2KV for power supply lines ±1KV for input/output lines	Mains power quality should be that of a typical commercial or hospital environment.
Surge IEC 61000-4-5	±1KV line(s) to line(s) ±2KV line(s) to earth	±1KV line(s) to line(s) ±2KV line(s) to earth	Mains power quality should be that of a typical commercial or hospital environment.
Voltage dips, short interruptions and voltage variations on power supply input lines IEC 61000-4-11	<5% $U_T$ (>95% dip in $U_T$ ) for 0.5 cycle 40% $U_T$ (60% dip in $U_T$ ) for 5 cycles 70% $U_T$ (30% dip in $U_T$ ) for 25 cycles <5% $U_T$ (>95% dip in $U_T$ ) for 5s	<5% $U_T$ (>95% dip in $U_T$ ) for 0.5 cycle 40% $U_T$ (60% dip in $U_T$ ) for 5 cycles 70% $U_T$ (30% dip in $U_T$ ) for 25 cycles <5% $U_T$ (>95% dip in $U_T$ ) for 5s	Mains power quality should be that of a typical commercial or hospital environment. If the user of the M-Turbo ultrasound system requires continued operation during power mains interruptions, it is recommended that the M-Turbo ultrasound system be powered from an uninterruptible power supply or a battery.

## Guidance and Manufacturer's Declaration - Electromagnetic Immunity (Continued)

The M-Turbo ultrasound system is intended for use in the electromagnetic environment specified below. The customer or the user of the M-Turbo ultrasound system should assure that it is used in such an environment.

Immunity Test	IEC 60601 Test Level	Compliance Level	Electromagnetic Environment
Power Frequency Magnetic Field IEC 61000-4-8	3 A/m	3 A/m	Power frequency magnetic fields should be at levels characteristic of a typical location in a typical commercial or hospital environment.
Conducted RF IEC 61000-4-6	3 Vrms 150 kHz to 80 MHz	3 Vrms	Portable and mobile RF communications equipment should be used no closer to any part of the M-Turbo ultrasound system, including cables, than the recommended separation distance calculated from the equation applicable to the frequency of the transmitter.  Recommended Separation Distance $d = 1.2 \sqrt{P}$

## Guidance and Manufacturer's Declaration - Electromagnetic Immunity (Continued)

The M-Turbo ultrasound system is intended for use in the electromagnetic environment specified below. The customer or the user of the M-Turbo ultrasound system should assure that it is used in such an environment.

Immunity Test	IEC 60601 Test Level	Compliance Level	Electromagnetic Environment
Radiated RF IEC 61000-4-3	3 Vim 80 MHz to 2.5 GHz	3 V/m	$d = 1.2 \sqrt{P}$ 80 MHz to 800 MHz $d = 2.3 \sqrt{P}$ 800 MHz to 2,5 GHz Where $P$ is the maximum output power rating of the transmitter in watts (W) according to the transmitter manufacturer and $d$ is the recommended separation distance in meters (m). Field strengths from fixed RF transmitters, as determined by an electromagnetic Site survey <sup>a</sup> , should be less than the compliance level in each frequency range <sup>b</sup> . Interference may occur in the vicinity of equipment marked with the following symbol: 

*Note:  $U_T$  is the AC mains voltage prior to application of the test level.*

*At 80 MHz and 800 MHz, the higher frequency range applies.*

*These guidelines may not apply in all situations. Electromagnetic propagation is affected by absorption and reflection from structures, objects and people.*

- a. Field strengths from fixed transmitters such as base stations for radio (cellular/cordless) telephones and land mobile radios, amateur radio, AM and FM radio broadcast and TV broadcast cannot be predicted theoretically with accuracy. To assess the electromagnetic environment due to fixed RF transmitters, an electromagnetic site survey should be considered. If the measured field strength in the location in which the SonoSite ultrasound system is used exceeds the applicable RF compliance level above, the SonoSite ultrasound system should be observed to verify normal operation. If abnormal performance is observed, additional measures may be necessary, such as re-orienting or relocating the SonoSite ultrasound system.
- b. Over the frequency range 150 kHz to 80 MHz, field strengths should be less than 3 V/m.

**FCC Caution:** Changes or modifications not expressly approved by the party responsible for compliance could void the user's authority to operate the equipment.

This device complies with part 15 of the FCC Rules. Operation is subject to the following two conditions:

- This device may not cause harmful interference.

This device must accept any interference received, including interference that may cause undesired operation.

## Immunity testing requirements

The M-Turbo ultrasound system complies with the essential performance requirements specified in IEC 60601-1-2 and IEC 60601-2-37. Results of immunity testing show that the M-Turbo ultrasound system meets these requirements and is free from the following:

- Noise on a waveform or artifacts or distortion in an image or error of a displayed numerical value that cannot be attributed to a physiological effect and that may alter the diagnosis
- Display of incorrect numerical values associated with the diagnosis to be performed
- Display of incorrect safety related indications
- Production of unintended or excessive ultrasound output
- Production of unintended or excessive transducer assembly surface temperature

Production of unintended or uncontrolled motion of transducer assemblies intended for intracorporeal use ALARA principle

ALARA is the guiding principle for the use of diagnostic ultrasound. Sonographers and other qualified ultrasound users, using good judgment and insight, determine the exposure that is "as low as reasonably achievable." There are no set rules to determine the correct exposure for every situation. The qualified ultrasound user determines the most appropriate way to keep exposure low and bioeffects to a minimum, while obtaining a diagnostic examination.

A thorough knowledge of the imaging modes, transducer capability, system setup and scanning technique is necessary. The imaging mode determines the nature of the ultrasound beam. A stationary beam results in a more concentrated exposure than a scanned beam, which spreads that exposure over that area. The transducer capability depends upon the frequency, penetration, resolution, and field of view. The default system presets are reset at the start of each new patient. It is the scanning technique of the qualified ultrasound user along with patient variability that determines the system settings throughout the exam.

The variables which affect the way the qualified ultrasound user implements the ALARA principle include: patient body size, location of the bone relative to the focal point, attenuation in the body, and ultrasound exposure time. Exposure time is an especially useful variable, because the qualified ultrasound user can control it. The ability to limit the exposure over time supports the ALARA principle.

## Applying ALARA

The system imaging mode selected by the qualified ultrasound user is determined by the diagnostic information required. 2D imaging provides anatomical information; CPD imaging provides information about the energy or amplitude strength of the Doppler signal over time at a given anatomical location and is used for detecting the presence of blood flow; Color imaging provides information about the energy or amplitude strength of the Doppler signal over time at a given anatomical location and is used for detecting the presence, velocity, and direction of blood flow; Tissue Harmonic Imaging uses higher received frequencies to reduce clutter, artifact, and improve resolution on the 2D image. Understanding the nature of the imaging mode used allows the qualified ultrasound user to apply the ALARA principle.

Prudent use of ultrasound requires that patient exposure to ultrasound be limited to the lowest ultrasound output for the shortest time necessary to achieve acceptable diagnostic results. Decisions that support prudent use are based on the type of patient, exam type, patient history, ease or difficulty of obtaining diagnostically useful information, and potential localized heating of the patient due to transducer surface temperature.

The system has been designed to ensure that temperature at the face of the transducer will not exceed the limits established in Section 42 of EN 60601-2-37: Particular requirement for the safety of ultrasound medical diagnostic and monitoring equipment. See “[Transducer surface temperature rise](#)” on page 120. In the event of a device malfunction, there are redundant controls that limit transducer power. This is accomplished by an electrical design that limits both power supply current and voltage to the transducer.

The sonographer uses the system controls to adjust image quality and limit ultrasound output. The system controls are divided into three categories relative to output: controls that directly affect output, controls that indirectly affect output, and receiver controls.

### Direct controls

The system does not exceed a spatial peak temporal average intensity (ISPTA) of 720 mW/cm<sup>2</sup> for all imaging modes. (For either the Ophthalmic or Orbital exam, the acoustic output is limited to the following values: ISPTA does not exceed 50 mW/cm<sup>2</sup>; TI does not exceed 1.0, and MI does not exceed 0.23.) The mechanical index (MI) and thermal index (TI) may exceed values greater than 1.0 on some transducers in some imaging modes. One may monitor the MI and TI values and adjust the controls to reduce these values. See “[Guidelines for reducing MI and TI](#)” on page 115. Additionally, one means for meeting the ALARA principle is to set the MI or TI values to a low index value and then modifying this level until a satisfactory image or Doppler mode is obtained. For more information on MI and TI, see BS EN 60601-2-37:2001: Annex HH.

### Indirect controls

The controls that indirectly affect output are controls affecting imaging mode, freeze, and depth. The imaging mode determines the nature of the ultrasound beam. Tissue attenuation is directly related to transducer frequency. The higher the PRF (pulse repetition frequency), the more output pulses occur over a period of time.

## Receiver controls

The receiver controls are the gain controls. Receiver controls do not affect output. They should be used, if possible, to improve image quality before using controls that directly or indirectly affect output.

## Acoustic artifacts

An acoustic artifact is information, present or absent in an image, that does not properly indicate the structure or flow being imaged. There are helpful artifacts that aid in diagnosis and those that hinder proper interpretation. Examples of artifacts include:

- Shadowing
- Through transmission
- Aliasing
- Reverberations
- Comet tails

For more information on detecting and interpreting acoustic artifacts, see the following reference:

Kremkau, Frederick W. *Diagnostic Ultrasound: Principles and Instruments*. 7th ed., W.B. Saunders Company, (Oct. 17, 2005).

## Guidelines for reducing MI and TI

The following are general guidelines for reducing MI or TI. If multiple parameters are given, the best results may be achieved by minimizing these parameters simultaneously. In some modes changing these parameters does not affect MI or TI. Changes to other parameters may also result in MI and TI reductions. Please note the MI and TI values on the right side of the screen.

**Table 1: MI**

Transducer	Depth
C8x	↑
C11x	↑
C60x	↑
HFL38x	↑
HFL50x	↑

**Table 1: MI** (Continued)

<b>Transducer</b>	<b>Depth</b>
ICTx	↑
L25x	↑
L38x	↑
L38xi	↑
P10x	↑
P21x	↑
SLAx	↑
TEEx	↑

↓ Decrease or lower setting of parameter to reduce MI.  
↑ Increase or raise setting of parameter to reduce MI.



**Table 2: TI (TIS, TIC, TIB)**

Transducer	Color Power Doppler Settings						PW Settings
	Box Width	Box Height	Box Depth	PRF	Depth	Optimize	
C8x	↓	—	—	—	↑	—	↓ (Depth)
C11x	—	—	↑	↓	↑	—	↓ (Depth)
C60x	↓	—	↑	↓	↑	—	↓ (PRF)
HFL38x	—	—	↑	↑	↑	—	↓ (Depth)
HFL50x	—	—	↑	↑	↑	—	↓ (Depth)
ICTx	—	↑	↑	↓	—	Exam Gyn	↓ (PRF)
L25x	↓	—	—	—	↑	—	↓ (PRF)
L38x	—	—	—	↓	—	—	↓ (Depth)
L38xi	↑	↑	—	—	—	—	↓ (Sample volume zone or size)
P10x	—	—	↑	↓	—	—	↓ (PRF)
P21x	—	↓	—	↓	↑	—	↓ (PRF)
SLAx	—	—	↑	↓	↑	—	↓ (PRF)
TEEx	—	—	—	↓	↓	—	↓ (PRF)

↓ Decrease or lower setting of parameter to reduce TI.  
↑ Increase or raise setting of parameter to reduce TI.

## Output display

The system meets the AIUM output display standard for MI and TI (see last reference in “[Related guidance documents](#)” below). Table 3 indicates for each transducer and operating mode when either the TI or MI is greater than or equal to a value of 1.0, thus requiring display.

*Note: The D2x transducer has a static continuous wave (CW) output. This output is fixed. Therefore, TI and MI values cannot be changed by any system controls available to the user.*

**Table 3: Modes in which a TI or MI  $\geq$  1.0**

Transducer Model	Index	2D/ M Mode	CPD/ Color	PW Doppler	CW Doppler
C8x	MI	Yes	Yes	Yes	—
	TIC, TIB, or TIS	No	No	Yes	—
C11x/8-5	MI	No	No	No	—
	TIC, TIB, or TIS	No	Yes	Yes	—
C60x/5-2	MI	Yes	No	No	—
	TIC, TIB, or TIS	No	No	Yes	—
D2x/2	MI	—	—	—	No
	TIC, TIB, or TIS	—	—	—	Yes
HFL38x/13-6	MI	Yes	Yes	Yes	—
	TIC, TIB, or TIS	No	Yes	Yes	—
HFL50x/15-6	MI	Yes	Yes	Yes	—
	TIC, TIB, or TIS	No	No	Yes	—
ICTx/8-5	MI	No	No	No	—
	TIC, TIB, or TIS	No	No	Yes	—
L25x/13-6	MI	Yes	No	No	—
	TIC, TIB, or TIS	No	No	Yes	—
L38x/10-5	MI	No	Yes	Yes	—
	TIC, TIB, or TIS	No	Yes	Yes	—
L38xi/10-5	MI	Yes	Yes	Yes	N/A
	TIC, TIB, or TIS	No	Yes	Yes	N/A

**Table 3: Modes in which a TI or MI  $\geq 1.0$  (Continued)**

Transducer Model	Index	2D/ M Mode	CPD/ Color	PW Doppler	CW Doppler
P10x/8-4	MI	No	Yes	Yes	No
	TIC, TIB, or TIS	Yes	Yes	Yes	Yes
P21x/5-1	MI	Yes	Yes	Yes	No
	TIC, TIB, or TIS	Yes	Yes	Yes	Yes
SLAx/13-6	MI	No	No	No	—
	TIC, TIB, or TIS	No	No	Yes	—
TEEx/8-3	MI	No	No	No	No
	TIC, TIB, or TIS	No	No	Yes	Yes

Even when MI is less than 1.0, the system provides a continuous real-time display of MI in all imaging modes, in increments of 0.1.

The system meets the output display standard for TI and provides a continuous real-time display of TI in all imaging modes, in increments of 0.1.

The TI consists of three user-selectable indices, and only one of these is displayed at any one time. In order to display TI properly and meet the ALARA principle, the user selects an appropriate TI based on the specific exam being performed. SonoSite provides a copy of *AIUM Medical Ultrasound Safety*, which contains guidance on determining which TI is appropriate (See “[Related guidance documents](#)” on page 120).

### MI and TI output display accuracy

The accuracy result for the MI is stated statistically. With 95% confidence, 95% of the measured MI values will be within +18% to -25% of the displayed MI value, or +0.2 of the displayed value, whichever value is larger.

The accuracy result for the TI is stated statistically. With 95% confidence, 95% of the measured TI values will be within +21% to -40% of the displayed TI value, or +0.2 of the displayed value, whichever value is larger. The values equate to +1dB to -3dB.

A displayed value of 0.0 for MI or TI means that the calculated estimate for the index is less than 0.05.

### Factors that contribute to display uncertainty

The net uncertainty of the displayed indices is derived by combining the quantified uncertainty from three sources: measurement uncertainty, system and transducer variability, and engineering assumptions and approximations made when calculating the display values.

Measurement errors of the acoustic parameters when taking the reference data are the major source of error that contributes to the display uncertainty. The measurement error is described in “[Acoustic measurement precision and uncertainty](#)” on page 165.

The displayed MI and TI values are based on calculations that use a set of acoustic output measurements that were made using a single reference ultrasound system with a single reference transducer that is representative of the population of transducers of that type. The reference system and transducer are chosen from a sample population of systems and transducers taken from early production units, and they are selected based on having an acoustic output that is representative of the nominal expected acoustic output for all transducer/system combinations that might occur. Of course every transducer/system combination has its own unique characteristic acoustic output, and will not match the nominal output on which the display estimates are based. This variability between systems and transducers introduces an error into displayed value. By doing acoustic output sampling testing during production, the amount of error introduced by the variability is bounded. The sampling testing ensures that the acoustic output of transducers and systems being manufactured stays within a specified range of the nominal acoustic output.

Another source of error arises from the assumptions and approximations that are made when deriving the estimates for the display indices. Chief among these assumptions is that the acoustic output, and thus the derived display indices, are linearly correlated with the transmit drive voltage of the transducer. Generally, this assumption is very good, but it is not exact, and thus some error in the display can be attributed to the assumption of voltage linearity.

## Related guidance documents

Information for Manufacturers Seeking Marketing Clearance of Diagnostic Ultrasound Systems and Transducers, FDA, 1997.

Medical Ultrasound Safety, American Institute of Ultrasound in Medicine (AIUM), 1994. (A copy is included with each system.)

Acoustic Output Measurement Standard for Diagnostic Ultrasound Equipment, NEMA UD2-2004.

Acoustic Output Measurement and Labeling Standard for Diagnostic Ultrasound Equipment, American Institute of Ultrasound in Medicine, 1993.

Standard for Real-Time Display of Thermal and Mechanical Acoustic Output Indices on Diagnostic Ultrasound Equipment, NEMA UD3-2004.

Guidance on the interpretation of TI and MI to be used to inform the operator, Annex HH, BS EN 60601-2-37 reprinted at P05699.

## Transducer surface temperature rise

Table 4 and Table 5 list the measured surface temperature rise from ambient ( $23^{\circ}\text{C} \pm 3^{\circ}\text{C}$ ) of transducers used on the ultrasound system. The temperatures were measured in accordance with EN 60601-2-37 section 42 with controls and settings positioned to give maximum temperatures.

**Table 4: Transducer Surface Temperature Rise, External Use (°C)**

Test	C8x	C11x	C60x	D2	HFL 38x	HFL 50x	L25x	L38x	L38xi	P10x	P21x
Still air	11.3	17.6	16.2	8.3	15.5	10.7	16.1	16.3	12.5	15.6	16.8
Simulated Use	5.5	9.1	8.8	1.9	7.9	7.7	8.5	9.6	8.8	9.8	9.0

**Table 5: Transducer Surface Temperature Rise, Internal Use (°C)**

Test	ICTx	SLAx	TEEx
Still air	9.2	9.5	9.3
Simulated Use	5.2	4.8	5.8

## Acoustic output measurement

Since the initial use of diagnostic ultrasound, the possible human biological effects (bioeffects) from ultrasound exposure have been studied by various scientific and medical institutions. In October 1987, the American Institute of Ultrasound in Medicine (AIUM) ratified a report from its Bioeffects Committee (Bioeffects Considerations for the Safety of Diagnostic Ultrasound, *J Ultrasound Med.*, Sept. 1988: Vol. 7, No. 9 Supplement). The report, sometimes referred to as *the Stowe Report*, reviewed available data on possible effects of ultrasound exposure. Another report, “Bioeffects and Safety of Diagnostic Ultrasound,” dated January 28, 1993, provides more current information.

The acoustic output for this ultrasound system has been measured and calculated in accordance with “Acoustic Output Measurement Standard for Diagnostic Ultrasound Equipment” (NEMA UD2-2004), and “Standard for Real-Time Display of Thermal and Mechanical Acoustic Output Indices on Diagnostic Ultrasound Equipment” (NEMA UDe3-2004).

### *In Situ*, derated, and water value intensities

All intensity parameters are measured in water. Since water does not absorb acoustic energy, these water measurements represent a worst case value. Biological tissue does absorb acoustic energy. The true value of the intensity at any point depends on the amount, type of tissue, and the frequency of the ultrasound passing through the tissue. The intensity value in the tissue, *In Situ*, has been estimated by using the following formula:

$$In\ Situ = Water [e^{-(0.23alf)}]$$

where:

$In\ Situ$  =  $In\ Situ$  intensity value

Water = Water intensity value

$e = 2.7183$

$a$  = attenuation factor (dB/cm MHz)

Attenuation factor ( $a$ ) for various tissue types are given below:

brain = 0.53

heart = 0.66

kidney = 0.79

liver = 0.43

muscle = 0.55

$l$  = skinline to measurement depth in cm

$f$  = center frequency of the transducer/system/mode combination in MHz

Since the ultrasonic path during the exam is likely to pass through varying lengths and types of tissue, it is difficult to estimate the true *In Situ* intensity. An attenuation factor of 0.3 is used for general reporting purposes; therefore, the *In Situ* value commonly reported uses the formula:

$$In\ Situ\ (derated) = Water [e^{-(0.069lf)}]$$

Since this value is not the true *In Situ* intensity, the term “derated” is used to qualify it.

The maximum derated and the maximum water values do not always occur at the same operating conditions; therefore, the reported maximum water and derated values may not be related by the *In Situ* (derated) formula. For example: a multi-zone array transducer that has maximum water value intensities in its deepest zone, but also has the smallest derating factor in that zone. The same transducer may have its largest derated intensity in one of its shallowest focal zones.

## Tissue models and equipment survey

Tissue models are necessary to estimate attenuation and acoustic exposure levels *In Situ* from measurements of acoustic output made in water. Currently, available models may be limited in their accuracy because of varying tissue paths during diagnostic ultrasound exposures and uncertainties in the acoustic properties of soft tissues. No single tissue model is adequate for predicting exposures in all situations from measurements made in water, and continued improvement and verification of these models is necessary for making exposure assessments for specific exam types.

A homogeneous tissue model with attenuation coefficient of 0.3 dB/cm MHz throughout the beam path is commonly used when estimating exposure levels. The model is conservative in that it overestimates the *In Situ* acoustic exposure when the path between the transducer and site of interest is composed entirely of soft tissue. When the path contains significant amounts of fluid, as in many first and second-trimester pregnancies scanned transabdominally, this model may underestimate the *In Situ* acoustic exposure. The amount of underestimation depends upon each specific situation.

Fixed-path tissue models, in which soft tissue thickness is held constant, sometimes are used to estimate *In Situ* acoustic exposures when the beam path is longer than 3 cm and consists largely of fluid. When this model is used to estimate maximum exposure to the fetus during transabdominal scans, a value of 1 dB/cm MHz may be used during all trimesters.

Existing tissue models that are based on linear propagation may underestimate acoustic exposures when significant saturation due to non-linear distortion of beams in water is present during the output measurement.

The maximum acoustic output levels of diagnostic ultrasound devices extend over a broad range of values:

- A survey of 1990-equipment models yielded MI values between 0.1 and 1.0 at their highest output settings. Maximum MI values of approximately 2.0 are known to occur for currently available equipment. Maximum MI values are similar for real-time 2D and M Mode imaging.
- Computed estimates of upper limits to temperature elevations during transabdominal scans were obtained in a survey of 1988 and 1990 pulsed Doppler equipment. The vast majority of models yielded upper limits less than 1° and 4°C (1.8° and 7.2°F) for exposures of first-trimester fetal tissue and second-trimester fetal bone, respectively. The largest values obtained were approximately 1.5°C (2.7°F) for first-trimester fetal tissue and 7°C (12.6°F) for second-trimester fetal bone. Estimated maximum temperature elevations given here are for a “fixed path” tissue model and are for devices having  $I_{SPTA}$  values greater than 500 mW/cm<sup>2</sup>. The temperature elevations for fetal bone and tissue were computed based on calculation procedures given in Sections 4.3.2.1-4.3.2.6 in “Bioeffects and Safety of Diagnostic Ultrasound” (AIUM, 1993).

## Acoustic output tables

Table 10 through Table 43 indicate the acoustic output for the system and transducer combinations with a TI or MI equal to or greater than one. These tables are organized by transducer model and imaging mode. For a definition of terms used in the tables, see “Terms used in the acoustic output tables” on page 164.

**Table 6: Transducer Model: C8x**

**Operating Mode: 2D**

Index Label		M.I.	TIS			TIB	TIC
			Scan	Non-scan		Non-scan	
				$A_{aprt} \leq 1$	$A_{aprt} > 1$		
Global Maximum Index Value		1.1	(a)	—	—	—	(b)
Associated Acoustic Parameter	$P_{r,3}$ (MPa)	2.48					
	$W_0$ (mW)		#	—	—	—	#
	min of [ $W_{.3}(z_1), I_{TA,3}(z_1)$ ] (mW)				—		
	$z_1$ (cm)				—		
	$z_{bp}$ (cm)				—		
	$z_{sp}$ (cm)	1.2				—	
	$d_{eq}(z_{sp})$ (cm)					—	
	$f_c$ (MHz)	5.53	#	—	—	—	#
	Dim of $A_{aprt}$	X (cm) Y (cm)		# #	— —	— —	— —
Other Information	PD ( $\mu$ sec)	0.239					
	PRF (Hz)	9524					
	$p_r@PII_{max}$ (MPa)	3.11					
	$d_{eq@PII_{max}}$ (cm)					—	
	Focal Length	FL <sub>x</sub> (cm) FL <sub>y</sub> (cm)		# #	— —	— —	# #
	$I_{PA,3@MI_{max}}$ (W/cm <sup>2</sup> )	264					
Operating Control Conditions	Control 1: Exam Type	Pro	—	—	—	—	—
	Control 2: Optimization	Pen	—	—	—	—	—
	Control 3: Depth	2.5 - 3.2	—	—	—	—	—
	Control 4: MB	Off	—	—	—	—	—

(a) This index is not required for this operating mode; value is <1.

(b) This transducer is not intended for transcranial or neonatal cephalic uses.

# No data is reported for this operating condition since the global maximum index value is not reported for the reason listed. (Reference Global Maximum Index Value line.)

— Data is not applicable for this transducer/mode.



**Table 7: Transducer Model: C8x**

**Operating Mode: M Mode**

Index Label		M.I.	TIS		TIB	TIC		
			Scan	Non-scan			Non-scan	
				A <sub>aprt</sub> ≤1	A <sub>aprt</sub> >1			
Global Maximum Index Value		1.4	—	(a)	—	(a)	(b)	
Associated Acoustic Parameter	P <sub>r.3</sub> (MPa)	3.16						
	W <sub>0</sub> (mW)		—	#		#	#	
	min of [W <sub>.3</sub> (z <sub>1</sub> ), I <sub>TA.3</sub> (z <sub>1</sub> )] (mW)				—			
	z <sub>1</sub> (cm)				—			
	z <sub>bp</sub> (cm)				—			
	z <sub>sp</sub> (cm)	1.1				#		
	d <sub>eq</sub> (z <sub>sp</sub> ) (cm)					#		
	f <sub>c</sub> (MHz)	5.07	—	#	—	#	#	
	Dim of A <sub>aprt</sub>	X (cm)		—	#	—	#	#
Y (cm)			—	#	—	#	#	
Other Information	PD (μsec)	0.427						
	PRF (Hz)	800						
	p <sub>r</sub> @PII <sub>max</sub> (MPa)	3.83						
	d <sub>eq</sub> @PII <sub>max</sub> (cm)					#		
	Focal Length	FL <sub>x</sub> (cm)		—	#	—		#
		FL <sub>y</sub> (cm)		—	#	—		#
I <sub>PA.3</sub> @MI <sub>max</sub> (W/cm <sup>2</sup> )	482							
Operating Control Conditions	Control 1: Exam Type	Pro	—	—	—	—	—	
	Control 2: Optimization	Pen	—	—	—	—	—	
	Control 3: Depth	4.2	—	—	—	—	—	

(a) This index is not required for this operating mode; value is <1.

(b) This transducer is not intended for transcranial or neonatal cephalic uses.

# No data is reported for this operating condition since the global maximum index value is not reported for the reason listed. (Reference Global Maximum Index Value line.)

— Data is not applicable for this transducer/mode.

**Table 8: Transducer Model: C8x**

**Operating Mode: Color**

Index Label		M.I.	TIS		TIB	TIC	
			Scan	Non-scan			Non-scan
				$A_{aprt} \leq 1$	$A_{aprt} > 1$		
Global Maximum Index Value		1.4	(a)	—	—	(b)	
Associated Acoustic Parameter	$P_{r,3}$ (MPa)	3.18					
	$W_0$ (mW)		#	—	—	#	
	min of [ $W_{.3}(z_1), I_{TA,3}(z_1)$ ] (mW)				—		
	$z_1$ (cm)				—		
	$z_{bp}$ (cm)				—		
	$z_{sp}$ (cm)	0.8				—	
	$d_{eq}(z_{sp})$ (cm)					—	
	$f_c$ (MHz)	4.82	#	—	—	—	#
	Dim of $A_{aprt}$	X (cm) Y (cm)		# #	— —	— —	# #
Other Information	PD ( $\mu$ sec)	0.694					
	PRF (Hz)	2548					
	$p_r@PII_{max}$ (MPa)	3.63					
	$d_{eq}@PII_{max}$ (cm)					—	
	Focal Length	$FL_x$ (cm) $FL_y$ (cm)		# #	— —	— —	# #
	$I_{PA,3}@MI_{max}$ (W/cm <sup>2</sup> )	555					
Operating Control Conditions	Control 1: Exam Type	Pro	—	—	—	—	
	Control 2: Mode	CVD	—	—	—	—	
	Control 3: 2D Optimization/Depth	Pen / 1.5 - 1.9	—	—	—	—	
	Control 4: Color Optimization/PRF	High / Any	—	—	—	—	
	Control 5: Color Box Position/Size	Short & narrow / Any	—	—	—	—	

(a) This index is not required for this operating mode; value is <1.

(b) This transducer is not intended for transcranial or neonatal cephalic uses.

# No data is reported for this operating condition since the global maximum index value is not reported for the reason listed. (Reference Global Maximum Index Value line.)

— Data is not applicable for this transducer/mode.

**Table 9: Transducer Model: C8x**

**Operating Mode: PW Doppler**

Index Label		M.I.	TIS		TIB	TIC		
			Scan	Non-scan			Non-scan	
				$A_{aprt} \leq 1$	$A_{aprt} > 1$			
Global Maximum Index Value		1.2	—	(a)	—	2.0	(b)	
Associated Acoustic Parameter	$P_{r,3}$ (MPa)	2.59						
	$W_0$ (mW)		—	#		36.0	#	
	min of [ $W_{.3}(z_1), I_{TA,3}(z_1)$ ] (mW)				—			
	$z_1$ (cm)				—			
	$z_{bp}$ (cm)				—			
	$z_{sp}$ (cm)	1.1				1.10		
	$d_{eq}(z_{sp})$ (cm)					0.28		
	$f_c$ (MHz)	4.79	—	#	—	4.79	#	
	Dim of $A_{aprt}$	X (cm)		—	#	—	1.12	#
Y (cm)			—	#	—	0.40	#	
Other Information	PD ( $\mu$ sec)	1.131						
	PRF (Hz)	1008						
	$p_r@PII_{max}$ (MPa)	3.10						
	$d_{eq}@PII_{max}$ (cm)					0.28		
	Focal Length	$FL_x$ (cm)		—	#	—		#
		$FL_y$ (cm)		—	#	—		#
$I_{PA,3}@MI_{max}$ ( $W/cm^2$ )	296							
Operating Control Conditions	Control 1: Exam Type	Pro	—	—	—	Pro	—	
	Control 2: Sample Volume Size	1 mm	—	—	—	1 mm	—	
	Control 3: Sample Volume Position	Zone 5	—	—	—	Zone 5	—	
	Control 4: PRF	1008	—	—	—	3125	—	

(a) This index is not required for this operating mode; value is <1.

(b) This transducer is not intended for transcranial or neonatal cephalic uses.

# No data is reported for this operating condition since the global maximum index value is not reported for the reason listed. (Reference Global Maximum Index Value line.)

— Data is not applicable for this transducer/mode.

**Table 10: Transducer Model: C11x**

**Operating Mode: CPD/Color**

Index Label		M.I.	TIS		TIB	TIC	
			Scan	Non-scan			Non-scan
				$A_{aprt} \leq 1$	$A_{aprt} > 1$		
Global Maximum Index Value		(a)	(a)	—	—	1.0	
Associated Acoustic Parameter	$P_{r,3}$ (MPa)	#					
	$W_0$ (mW)		#	—	—	38.8	
	min of [ $W_{,3}(z_1), I_{TA,3}(z_1)$ ] (mW)				—		
	$z_1$ (cm)				—		
	$z_{bp}$ (cm)				—		
	$z_{sp}$ (cm)	#				—	
	$d_{eq}(z_{sp})$ (cm)					—	
	$f_c$ (MHz)	#	#	—	—	—	4.37
	Dim of $A_{aprt}$	X (cm)		#	—	—	—
Y (cm)			#	—	—	—	0.50
Other Information	PD ( $\mu$ sec)	#					
	PRF (Hz)	#					
	$p_r@PII_{max}$ (MPa)	#					
	$d_{eq}@PII_{max}$ (cm)					—	
	Focal Length	$FL_x$ (cm)		#	—	—	4.29
		$FL_y$ (cm)		#	—	—	4.40
$I_{PA,3}@MI_{max}$ ( $W/cm^2$ )		#					
Operating Control Conditions	Control 1: Mode						Any
	Control 2: Exam Type						Abd
	Control 3: PRF						3676
	Control 4: Optimization/Depth						Low/5.1
	Control 5: Color Box Position/Size						Top/Short & Narrow

(a) This index is not required for this operating mode; value is <1.

(b) This transducer is not intended for transcranial or neonatal cephalic uses.

# No data are reported for this operating condition since the global maximum index value is not reported for the reason listed. (Reference Global Maximum Index Value line.)

— Data are not applicable for this transducer/mode.

**Table 11: Transducer Model: C11x**

**Operating Mode: PW Doppler**

Index Label		M.I.	TIS			TIB	TIC	
			Scan	Non-scan		Non-scan		
				$A_{aprt} \leq 1$	$A_{aprt} > 1$			
Global Maximum Index Value		(a)	—	1.0	—	1.7	1.8	
Associated Acoustic Parameter	$p_{r,3}$ (MPa)	#	—	—	—	—	—	
	$W_0$ (mW)		—	46.0	—	24.9	25.4	
	min of [ $W_{,3}(z_1), I_{TA,3}(z_1)$ ] (mW)		—	—	—	—	—	
	$z_1$ (cm)		—	—	—	—	—	
	$z_{bp}$ (cm)		—	—	—	—	—	
	$z_{sp}$ (cm)	#	—	—	—	1.06	—	
	$d_{eq}(z_{sp})$ (cm)		—	—	—	0.24	—	
	$f_c$ (MHz)	#	—	4.36	—	4.37	4.36	
	Dim of $A_{aprt}$	X (cm)		—	1.76	—	0.28	0.20
		Y (cm)		—	0.50	—	0.50	0.50
Other Information	PD ( $\mu$ sec)	#	—	—	—	—	—	
	PRF (Hz)	#	—	—	—	—	—	
	$p_r@PII_{max}$ (MPa)	#	—	—	—	—	—	
	$d_{eq}@PII_{max}$ (cm)		—	—	—	0.23	—	
	Focal Length	$FL_x$ (cm)		—	6.37	—	—	0.77
		$FL_y$ (cm)		—	4.40	—	—	4.40
	$I_{PA,3}@MI_{max}$ ( $W/cm^2$ )	#	—	—	—	—	—	
Operating Control Conditions	Control 1: Exam Type			Any		Any	Any	
	Control 2: Sample Volume			2 mm		1 mm	1 mm	
	Control 3: PRF			3906		10417	20833	
	Control 4: Sample Volume Position			Zone 7		Zone 1	Zone 0	

(a) This index is not required for this operating mode; value is <1.

(b) This transducer is not intended for transcranial or neonatal cephalic uses.

# No data are reported for this operating condition since the global maximum index value is not reported for the reason listed. (Reference Global Maximum Index Value line.)

— Data are not applicable for this transducer/mode.

**Table 12: Transducer Model: C60x**

**Operating Mode: 2D**

Index Label		M.I.	TIS			TIB	TIC	
			Scan	Non-scan		Non-scan		
				$A_{aprt} \leq 1$	$A_{aprt} > 1$			
Global Maximum Index Value		1.0	(a)	—	—	—	(b)	
Associated Acoustic Parameter	$P_{r,3}$ (MPa)	1.69						
	$W_0$ (mW)		#	—		—	#	
	min of [ $W_{,3}(z_1), I_{TA,3}(z_1)$ ] (mW)				—			
	$z_1$ (cm)				—			
	$z_{bp}$ (cm)				—			
	$z_{sp}$ (cm)	4.7				—		
	$d_{eq}(z_{sp})$ (cm)					—		
	$f_c$ (MHz)	2.84	#	—	—	—	#	
	Dim of $A_{aprt}$	X (cm)		#	—	—	—	#
Y (cm)			#	—	—	—	#	
Other Information	PD ( $\mu$ sec)	0.579						
	PRF (Hz)	5440						
	$p_r@PII_{max}$ (MPa)	2.679						
	$d_{eq}@PII_{max}$ (cm)					—		
	Focal Length	$FL_x$ (cm)		#	—	—		#
		$FL_y$ (cm)		#	—	—		#
$I_{PA,3}@MI_{max}$ ( $W/cm^2$ )	197.7							
Operating Control Conditions	Control 1: Exam Type	Abd/OB						
	Control 2: Optimization	Any						
	Control 3: Depth	11/ 13 cm						
	Control 4: THI	On						
	Control 5: MB (Multi Beam)	On						

(a) This index is not required for this operating mode; value is <1.

(b) This transducer is not intended for transcranial or neonatal cephalic uses.

# No data are reported for this operating condition since the global maximum index value is not reported for the reason listed. (Reference Global Maximum Index Value line.)

— Data are not applicable for this transducer/mode.

**Table 13: Transducer Model: C60x**

**Operating Mode: M Mode**

Index Label		M.I.	TIS		TIB	TIC		
			Scan	Non-scan			Non-scan	
				$A_{aprt} \leq 1$	$A_{aprt} > 1$			
Global Maximum Index Value		1.0	—	(a)	—	(a)	(b)	
Associated Acoustic Parameter	$p_{r,3}$ (MPa)	1.62						
	$W_0$ (mW)		—	#		#	#	
	min of [ $W_{,3}(z_1), I_{TA,3}(z_1)$ ] (mW)				—			
	$z_1$ (cm)				—			
	$z_{bp}$ (cm)				—			
	$z_{sp}$ (cm)	4.7				#		
	$d_{eq}(z_{sp})$ (cm)					#		
	$f_c$ (MHz)	2.85	—	#	—	#	#	
	Dim of $A_{aprt}$	X (cm)		—	#	—	#	#
Y (cm)			—	#	—	#	#	
Other Information	PD ( $\mu$ sec)	0.577						
	PRF (Hz)	800						
	$p_r@PII_{max}$ (MPa)	2.576						
	$d_{eq}@PII_{max}$ (cm)					#		
	Focal Length	$FL_x$ (cm)		—	#	—		#
		$FL_y$ (cm)		—	#	—		#
$I_{PA,3}@MI_{max}$ ( $W/cm^2$ )		184.3						
Operating Control Conditions	Control 1: Exam Type		Any					
	Control 2: Optimization		Pen					
	Control 3: Depth		7.8 cm					
	Control 4: MB (Multi Beam)		Off or On					

(a) This index is not required for this operating mode; value is <1.

(b) This transducer is not intended for transcranial or neonatal cephalic uses.

# No data are reported for this operating condition since the global maximum index value is not reported for the reason listed. (Reference Global Maximum Index Value line.)

— Data are not applicable for this transducer/mode.

**Table 14: Transducer Model: C60x**

**Operating Mode: PW Doppler**

Index Label		M.I.	TIS			TIB	TIC	
			Scan	Non-scan		Non-scan		
				$A_{aprt} \leq 1$	$A_{aprt} > 1$			
Global Maximum Index Value		(a)	—	(a)	—	3.1	(b)	
Associated Acoustic Parameter	$p_{r,3}$ (MPa)	#						
	$W_0$ (mW)		—	#		85.64	#	
	min of [ $W_{.3}(z_1), I_{TA,3}(z_1)$ ] (mW)				—			
	$z_1$ (cm)				—			
	$z_{bp}$ (cm)				—			
	$z_{sp}$ (cm)	#				1.255		
	$d_{eq}(z_{sp})$ (cm)					0.51		
	$f_c$ (MHz)	#	—	#	—	2.233	#	
	Dim of $A_{aprt}$	X (cm)		—	#	—	0.6552	#
Y (cm)			—	#	—	1.3	#	
Other Information	PD (µsec)	#						
	PRF (Hz)	#						
	$p_r@PII_{max}$ (MPa)	#						
	$d_{eq}@PII_{max}$ (cm)					0.415		
	Focal Length	$FL_x$ (cm)		—	#	—		#
		$FL_y$ (cm)		—	#	—		#
$I_{PA,3}@MI_{max}$ (W/cm <sup>2</sup> )	#							
Operating Control Conditions	Control 1: Exam Type					Abd		
	Control 2: PRF					Any		
	Control 3: Sample Volume					12 mm		
	Control 4: Sample Volume Position					Zone 1		

(a) This index is not required for this operating mode; value is <1.

(b) This transducer is not intended for transcranial or neonatal cephalic uses.

# No data are reported for this operating condition since the global maximum index value is not reported for the reason listed. (Reference Global Maximum Index Value line.)

— Data are not applicable for this transducer/mode.



**Table 15: Transducer Model: D2x**

**Operating Mode: CW Doppler**

Index Label		M.I.	TIS			TIB	TIC	
			Scan	Non-scan		Non-scan		
				A <sub>aprt</sub> ≤1	A <sub>aprt</sub> >1			
Global Maximum Index Value		(a)	—	(a)	—	2.6	(b)	
Associated Acoustic Parameter	p <sub>r,3</sub> (MPa)	#						
	W <sub>0</sub> (mW)		—	#		90.52	#	
	min of [W <sub>3</sub> (z <sub>1</sub> ), I <sub>TA,3</sub> (z <sub>1</sub> )] (mW)				—			
	z <sub>1</sub> (cm)				—			
	z <sub>bp</sub> (cm)				—			
	z <sub>sp</sub> (cm)	#				1.1		
	d <sub>eq</sub> (z <sub>sp</sub> ) (cm)					0.66		
	f <sub>c</sub> (MHz)	#	—	#	—	2.00	#	
	Dim of A <sub>aprt</sub>	X (cm)		—	#	—	0.8	#
Y (cm)			—	#	—	0.4	#	
Other Information	PD (μsec)	#						
	PRF (Hz)	#						
	p <sub>r</sub> @PII <sub>max</sub> (MPa)	#						
	d <sub>eq</sub> @PII <sub>max</sub> (cm)					0.54		
	Focal Length	FL <sub>x</sub> (cm)		—	#	—		#
		FL <sub>y</sub> (cm)		—	#	—		#
I <sub>PA,3</sub> @MI <sub>max</sub> (W/cm <sup>2</sup> )	#							
Operating Control Conditions	Control 1: Exam Type					Crd		
	Control 2: Depth					Fixed		
	Control 3: Zone					Fixed		

(a) This index is not required for this operating mode; value is <1.

(b) This transducer is not intended for transcranial or neonatal cephalic uses.

# No data are reported for this operating condition since the global maximum index value is not reported for the reason listed. (Reference Global Maximum Index Value line.)

— Data are not applicable for this transducer/mode.

**Table 16: Transducer Model: HFL38x/13-6**

**Operating Mode: 2D**

Index Label		MI	TIS			TIB	TIC
			Scan	Non-scan		Non-scan	
				A <sub>aprt</sub> ≤1	A <sub>aprt</sub> >1		
Global Maximum Index Value		1.1	(a)	—	—	—	(b)

**Table 16: Transducer Model: HFL38x/13-6**

**Operating Mode: 2D**

Index Label		MI	TIS			TIB	TIC	
			Scan	Non-scan		Non-scan		
				$A_{aprt} \leq 1$	$A_{aprt} > 1$			
Associated Acoustic Parameter	Pr,3 (MPa)	2.56						
	W <sub>0</sub> (mW)		#	—		—	#	
	min of [W <sub>.3</sub> (z <sub>1</sub> ), I <sub>TA,3</sub> (z <sub>1</sub> )] (mW)				—			
	z <sub>1</sub> (cm)				—			
	z <sub>bp</sub> (cm)				—			
	z <sub>sp</sub> (cm)					—		
	z@PII <sub>.3max</sub>	1.2						
	d <sub>eq</sub> (z <sub>sp</sub> ) (cm)					—		
	f <sub>c</sub> (MHz)	5.33	#	—	—	—	#	
	Dim of A <sub>aprt</sub>	X (cm)		#	—	—	—	#
Y (cm)			#	—	—	—	#	
Other Information	PD (μsec)	0.525						
	PRF (Hz)	2450						
	p <sub>r</sub> @PII <sub>max</sub> (MPa)	3.19						
	d <sub>eq</sub> @PII <sub>max</sub> (cm)					—		
	Focal Length	FL <sub>x</sub> (cm)		#	—	—		#
		FL <sub>y</sub> (cm)		#	—	—		#
I <sub>PA,3</sub> @MI <sub>max</sub> (W/cm <sup>2</sup> )	325.3							
Operating Control Conditions	Control 1: Exam Type	Nrv/Bre/SmP/Msk	—	—	—	—	—	
	Control 2: Optimization	Any	—	—	—	—	—	
	Control 3: Depth	3.3 cm	—	—	—	—	—	
	Control 4: MBe	On	—	—	—	—	—	

(a) This index is not required for this operating mode; value is <1.

(b) This transducer is not intended for transcranial or neonatal cephalic uses.

# No data are reported for this operating condition since the global maximum index value is not reported for the reason listed. (Reference Global Maximum Index Value line.)— Data are not applicable for this transducer/mode.

— Data are not applicable for this transducer/mode.

**Table 17: Transducer Model: HFL38x**

**Operating Mode: CPD/Color**

Index Label		M.I.	TIS			TIB	TIC	
			Scan	Non-scan		Non-scan		
				$A_{aprt} \leq 1$	$A_{aprt} > 1$			
Global Maximum Index Value		1.1	1.0	—	—	—	(b)	
Associated Acoustic Parameter	$p_{r,3}$ (MPa)	2.556						
	$W_0$ (mW)		37.69	—	—	—	#	
	min of [ $W_{.3}(z_1), I_{TA,3}(z_1)$ ] (mW)				—			
	$z_1$ (cm)				—			
	$z_{bp}$ (cm)				—			
	$z_{sp}$ (cm)	1.2				—		
	$d_{eq}(z_{sp})$ (cm)					—		
	$f_c$ (MHz)	5.328	5.324	—	—	—	#	
	Dim of $A_{aprt}$	X (cm)		0.44	—	—	—	#
Y (cm)			0.4	—	—	—	#	
Other Information	PD ( $\mu$ sec)	0.525						
	PRF (Hz)	2597						
	$p_r@PII_{max}$ (MPa)	3.187						
	$d_{eq}@PII_{max}$ (cm)					—		
	Focal Length	$FL_x$ (cm)		1.32	—	—		#
		$FL_y$ (cm)		2.5	—	—		#
$I_{PA,3}@MI_{max}$ ( $W/cm^2$ )	325.5							
Operating Control Conditions	Control 1: Mode		Color	Color	—	—	—	
	Control 2: Exam Type		Any	Ven	—	—	—	
	Control 3: Optimization/Depth/PRF		Low/3.3 cm/Any	Med/ 2.7 cm/ 2841	—	—	—	
	Control 4: Color Box Position/Size		Any	Top/Short	—	—	—	

(a) This index is not required for this operating mode; value is <1.

(b) This transducer is not intended for transcranial or neonatal cephalic uses.

# No data are reported for this operating condition since the global maximum index value is not reported for the reason listed. (Reference Global Maximum Index Value line.)

— Data are not applicable for this transducer/mode.

**Table 18: Transducer Model: HFL38x**

**Operating Mode: PW Doppler**

Index Label		M.I.	TIS			TIB	TIC	
			Scan	Non-scan		Non-scan		
				$A_{\text{aprt}} \leq 1$	$A_{\text{aprt}} > 1$			
Global Maximum Index Value		1.0	—	1.1	—	2.0	(b)	
Associated Acoustic Parameter	$P_{r,3}$ (MPa)	2.37	—	—	—	—	—	
	$W_0$ (mW)	—	—	43.01	—	43.01	#	
	min of [ $W_{.3}(z_1), I_{TA,3}(z_1)$ ] (mW)	—	—	—	—	—	—	
	$z_1$ (cm)	—	—	—	—	—	—	
	$z_{bp}$ (cm)	—	—	—	—	—	—	
	$z_{sp}$ (cm)	0.9	—	—	—	1.1	—	
	$d_{eq}(z_{sp})$ (cm)	—	—	—	—	0.33	—	
	$f_c$ (MHz)	5.32	—	5.30	—	5.30	#	
	Dim of $A_{\text{aprt}}$	X (cm)	—	—	1.04	—	1.04	#
Y (cm)		—	—	0.4	—	0.4	#	
Other Information	PD ( $\mu\text{sec}$ )	1.29	—	—	—	—	—	
	PRF (Hz)	1008	—	—	—	—	—	
	$p_r@PII_{\text{max}}$ (MPa)	2.404	—	—	—	—	—	
	$d_{eq}@PII_{\text{max}}$ (cm)	—	—	—	—	0.21	—	
	Focal Length	$FL_x$ (cm)	—	—	3.72	—	—	#
		$FL_y$ (cm)	—	—	2.5	—	—	#
$I_{PA,3}@MI_{\text{max}}$ ( $W/cm^2$ )	323.35	—	—	—	—	—		
Operating Control Conditions	Control 1: Exam Type	Bre/Vas SmP/IMT	—	Any	—	Any	—	
	Control 2: Sample Volume	1 mm	—	1 mm	—	1 mm	—	
	Control 3: PRF	1008	—	6250	—	6250	—	
	Control 4: Sample Volume Position	Zone 2	—	Zone 7	—	Zone 7	—	

(a) This index is not required for this operating mode; value is <1.

(b) This transducer is not intended for transcranial or neonatal cephalic uses.

# No data are reported for this operating condition since the global maximum index value is not reported for the reason listed. (Reference Global Maximum Index Value line.)

— Data are not applicable for this transducer/mode

**Table 19: Transducer Model: HFL50x**

**Operating Mode: 2D**

Index Label		M.I.	TIS			TIB	TIC	
			Scan	Non-scan		Non-scan		
				$A_{aprt} \leq 1$	$A_{aprt} > 1$			
Global Maximum Index Value		1.3	(a)	—	—	—	(b)	
Associated Acoustic Parameter	$p_{r,3}$ (MPa)	3.051						
	$W_0$ (mW)		#	—	—	—	#	
	min of [ $W_{.3}(z_1), I_{TA,3}(z_1)$ ] (mW)				—			
	$z_1$ (cm)				—			
	$z_{bp}$ (cm)				—			
	$z_{sp}$ (cm)	1.2				—		
	$d_{eq}(z_{sp})$ (cm)					—		
	$f_c$ (MHz)	5.36	#	—	—	—	#	
	Dim of $A_{aprt}$	X (cm)		#	—	—	—	#
Y (cm)			#	—	—	—	#	
Other Information	PD ( $\mu$ sec)	0.5.21						
	PRF (Hz)	2733						
	$p_r@PII_{max}$ (MPa)	3.81						
	$d_{eq}@PII_{max}$ (cm)					—		
	Focal Length	FL <sub>x</sub> (cm)		#	—	—		#
		FL <sub>y</sub> (cm)		#	—	—		#
$I_{PA,3}@MI_{max}$ (W/cm <sup>2</sup> )	493							
Operating Control Conditions	Control 1: Exam Type		Any	—	—	—	—	
	Control 2: Optimization		Any	—	—	—	—	
	Control 3: Depth		3.3	—	—	—	—	
	Control 4: MB		On	—	—	—	—	

(a) This index is not required for this operating mode; value is <1.

(b) This transducer is not intended for transcranial or neonatal cephalic uses.

# No data are reported for this operating condition since the global maximum index value is not reported for the reason listed. (Reference Global Maximum Index Value line.)

— Data are not applicable for this transducer/mode.

**Table 20: Transducer Model: HFL50x**

**Operating Mode: M Mode**

Index Label		M.I.	TIS			TIB	TIC	
			Scan	Non-scan		Non-scan		
				$A_{aprt} \leq 1$	$A_{aprt} > 1$			
Global Maximum Index Value		1.2	—	(a)	—	(a)	(b)	
Associated Acoustic Parameter	$p_{r,3}$ (MPa)	3.14						
	$W_0$ (mW)		—	#		#	#	
	min of [ $W_{.3}(z_1), I_{TA,3}(z_1)$ ] (mW)				—			
	$z_1$ (cm)				—			
	$z_{bp}$ (cm)				—			
	$z_{sp}$ (cm)	1.4				#		
	$d_{eq}(z_{sp})$ (cm)					#		
	$f_c$ (MHz)	6.75	—	#	—	#	#	
	Dim of $A_{aprt}$	X (cm)		—	#	—	#	#
Y (cm)			—	#	—	#	#	
Other Information	PD ( $\mu$ sec)	0.263						
	PRF (Hz)	1600						
	$p_r@PII_{max}$ (MPa)	4.35						
	$d_{eq}@PII_{max}$ (cm)					#		
	Focal Length	$FL_x$ (cm)		—	#	—		#
		$FL_y$ (cm)		—	#	—		#
$I_{PA,3}@MI_{max}$ ( $W/cm^2$ )	388							
Operating Control Conditions	Control 1: Exam Type	Any						
	Control 2: Optimization	Pen						
	Control 3: Depth	4.0						

(a) This index is not required for this operating mode; value is <1.

(b) This transducer is not intended for transcranial or neonatal cephalic uses.

# No data are reported for this operating condition since the global maximum index value is not reported for the reason listed. (Reference Global Maximum Index Value line.)

— Data are not applicable for this transducer/mode.



**Table 21: Transducer Model: HFL50x**

**Operating Mode: CPD/Color**

Index Label		M.I.	TIS		TIB	TIC	
			Scan	Non-scan			Non-scan
				$A_{aprt} \leq 1$	$A_{aprt} > 1$		
Global Maximum Index Value		1.3	(a)	—	—	(b)	
Associated Acoustic Parameter	$P_{r,3}$ (MPa)	3.05					
	$W_0$ (mW)		#	—	—	#	
	min of [ $W_{.3}(z_1), I_{TA,3}(z_1)$ ] (mW)				—		
	$z_1$ (cm)				—		
	$z_{bp}$ (cm)				—		
	$z_{sp}$ (cm)	1.2			—		
	$d_{eq}(z_{sp})$ (cm)				—		
	$f_c$ (MHz)	5.36	#	—	—	—	#
	Dim of $A_{aprt}$	X (cm)		#	—	—	—
Y (cm)			#	—	—	—	#
Other Information	PD ( $\mu$ sec)	0.521					
	PRF (Hz)	8233					
	$p_{r@PII_{max}}$ (MPa)	3.81					
	$d_{eq@PII_{max}}$ (cm)				—		
	Focal Length	$FL_x$ (cm)		#	—	—	#
		$FL_y$ (cm)		#	—	—	#
$I_{PA,3@MI_{max}}$ ( $W/cm^2$ )	494						
Operating Control Conditions	Control 1: Mode	Any					
	Control 2: Exam Type	Any					
	Control 3: Optimization/Depth	Low/3.3					
	Control 4: PRF	Any					

(a) This index is not required for this operating mode; value is <1.

(b) This transducer is not intended for transcranial or neonatal cephalic uses.

# No data are reported for this operating condition since the global maximum index value is not reported for the reason listed. (Reference Global Maximum Index Value line.)

— Data are not applicable for this transducer/mode.



**Table 22: Transducer Model: HFL50x**

**Operating Mode: PW Doppler**

Index Label		M.I.	TIS			TIB	TIC	
			Scan	Non-scan		Non-scan		
				$A_{aprt} \leq 1$	$A_{aprt} > 1$			
Global Maximum Index Value		1.2	—	1.1	—	1.9	(b)	
Associated Acoustic Parameter	$p_{r,3}$ (MPa)	2.69	—	—	—	—	—	
	$W_0$ (mW)	—	—	42.6	—	42.6	#	
	min of [ $W_{.3}(z_1), I_{TA,3}(z_1)$ ] (mW)	—	—	—	—	—	—	
	$z_1$ (cm)	—	—	—	—	—	—	
	$z_{bp}$ (cm)	—	—	—	—	—	—	
	$z_{sp}$ (cm)	1.0	—	—	—	1.1	—	
	$d_{eq}(z_{sp})$ (cm)	—	—	—	—	0.33	—	
	$f_c$ (MHz)	5.34	—	5.34	—	5.34	#	
	Dim of $A_{aprt}$	X (cm)	—	—	1.08	—	1.08	#
Y (cm)		—	—	0.40	—	0.40	#	
Other Information	PD ( $\mu$ sec)	1.29	—	—	—	—	—	
	PRF (Hz)	1008	—	—	—	—	—	
	$p_r@PII_{max}$ (MPa)	3.23	—	—	—	—	—	
	$d_{eq}@PII_{max}$ (cm)	—	—	—	—	0.22	—	
	Focal Length	FL <sub>x</sub> (cm)	—	—	3.72	—	—	#
		FL <sub>y</sub> (cm)	—	—	2.44	—	—	#
$I_{PA,3}@MI_{max}$ (W/cm <sup>2</sup> )	308	—	—	—	—	—		
Operating Control Conditions	Control 1: Exam Type	Any	—	Any	—	Any	—	
	Control 2: Sample Volume	1 mm	—	1 mm	—	1 mm	—	
	Control 3: PRF	1008	—	1563 - 3125	—	1563 - 3125	—	
	Control 4: Sample Volume Position	Zone 4	—	Zone 8	—	Zone 8	—	

(a) This index is not required for this operating mode; value is <1.

(b) This transducer is not intended for transcranial or neonatal cephalic uses.

# No data are reported for this operating condition since the global maximum index value is not reported for the reason listed. (Reference Global Maximum Index Value line.)

— Data are not applicable for this transducer/mode.

**Table 23: Transducer Model: ICTx**

**Operating Mode: PW Doppler**

Index Label		M.I.	TIS			TIB	TIC	
			Scan	Non-scan		Non-scan		
				$A_{aprt} \leq 1$	$A_{aprt} > 1$			
Global Maximum Index Value		(a)	—	(a)	—	1.2	(a)	
Associated Acoustic Parameter	$p_{r,3}$ (MPa)	#						
	$W_0$ (mW)		—	#		16.348	#	
	min of [ $W_3(z_1), I_{TA,3}(z_1)$ ] (mW)				—			
	$z_1$ (cm)				—			
	$z_{bp}$ (cm)				—			
	$z_{sp}$ (cm)	#				1.6		
	$d_{eq}(z_{sp})$ (cm)					0.192		
	$f_c$ (MHz)	#	—	#	—	4.36	#	
	Dim of $A_{aprt}$	X (cm)		—	#	—	0.6	#
Y (cm)			—	#	—	0.5	#	
Other Information	PD ( $\mu$ sec)	#						
	PRF (Hz)	#						
	$p_r@PII_{max}$ (MPa)	#						
	$d_{eq}@PII_{max}$ (cm)					0.187		
	Focal Length	$FL_x$ (cm)		—	#	—		#
		$FL_y$ (cm)		—	#	—		#
$I_{PA,3}@MI_{max}$ ( $W/cm^2$ )		#						
Operating Control Conditions	Control 1: Exam Type					Any		
	Control 2: Sample Volume					3 mm		
	Control 3: PRF					Any		
	Control 4: Sample Volume Position					Zone 1		

(a) This index is not required for this operating mode; value is <1.

(b) This transducer is not intended for transcranial or neonatal cephalic uses.

# No data are reported for this operating condition since the global maximum index value is not reported for the reason listed. (Reference Global Maximum Index Value line.)

— Data are not applicable for this transducer/mode.

**Table 24: Transducer Model: L25x**

**Operating Mode: 2D**

Index Label		M.I.	TIS		TIB	TIC	
			Scan	Non-scan			Non-scan
				$A_{aprt} \leq 1$	$A_{aprt} > 1$		
Global Maximum Index Value		1.2	(a)	—	—	(b)	
Associated Acoustic Parameter	$P_{r,3}$ (MPa)	2.87					
	$W_0$ (mW)		#	—	—	#	
	min of [ $W_{,3}(z_1), I_{TA,3}(z_1)$ ] (mW)				—		
	$z_1$ (cm)				—		
	$z_{bp}$ (cm)				—		
	$z_{sp}$ (cm)	0.8				—	
	$d_{eq}(z_{sp})$ (cm)					—	
	$f_c$ (MHz)	6.11	#	—	—	—	#
	Dim of $A_{aprt}$	X (cm)		#	—	—	—
Y (cm)			#	—	—	—	#
Other Information	PD (μsec)	0.630					
	PRF (Hz)	1061					
	$p_r@PII_{max}$ (MPa)	3.39					
	$d_{eq}@PII_{max}$ (cm)					—	
	Focal Length	$FL_x$ (cm)		#	—	—	#
		$FL_y$ (cm)		#	—	—	#
$I_{PA,3}@MI_{max}$ (W/cm <sup>2</sup> )	478						
Operating Control Conditions	Control 1: Exam Type	Nrv/Msk/Ven/Vas	—	—	—	—	
	Control 2: Optimization	Any	—	—	—	—	
	Control 3: Depth	1.9 - 2.2	—	—	—	—	
	Control 4: MBe	On	—	—	—	—	

- (a) This index is not required for this operating mode; value is <1.
- (b) This transducer is not intended for transcranial or neonatal cephalic uses.
- # No data are reported for this operating condition since the global maximum index value is not reported for the reason listed. (Reference Global Maximum Index Value line.)
- Data are not applicable for this transducer/mode.

**Table 25: Transducer Model L25x**

**Operating Mode: PW Doppler**

Index Label		M.I.	TIS			TIB	TIC	
			Scan	Non-scan		Non-scan		
				$A_{aprt} \leq 1$	$A_{aprt} > 1$			
Global Maximum Index Value		(a)	—	(a)	—	1.7	(b)	
Associated Acoustic Parameter	$p_{r,3}$ (MPa)	#						
	$W_0$ (mW)		—	#		32.1	#	
	min of [ $W_{.3}(z_1), I_{TA.3}(z_1)$ ] (mW)				—			
	$z_1$ (cm)				—			
	$z_{bp}$ (cm)				—			
	$z_{sp}$ (cm)	#				0.75		
	$d_{eq}(z_{sp})$ (cm)					0.30		
	$f_c$ (MHz)	#	—	#	—	6.00	#	
	Dim of $A_{aprt}$	X (cm)		—	#	—	0.76	#
Y (cm)			—	#	—	0.30	#	
Other Information	PD ( $\mu$ sec)	#						
	PRF (Hz)	#						
	$p_r@PII_{max}$ (MPa)	#						
	$d_{eq}@PII_{max}$ (cm)					0.21		
	Focal Length	$FL_x$ (cm)		—	#	—		#
		$FL_y$ (cm)		—	#	—		#
$I_{PA.3}@MI_{max}$ ( $W/cm^2$ )		#						
Operating Control Conditions	Control 1: Exam Type		—	—	—	Vas/Ven/Nrv	—	
	Control 2: Sample Volume		—	—	—	8 mm	—	
	Control 3: PRF		—	—	—	1953	—	
	Control 4: Sample Volume Position		—	—	—	Zone 7	—	

(a) This index is not required for this operating mode; value is <1.

(b) This transducer is not intended for transcranial or neonatal cephalic uses.

# No data are reported for this operating condition since the global maximum index value is not reported for the reason listed. (Reference Global Maximum Index Value line.)—Data are not applicable for this transducer/mode.

**Table 26: Transducer Model: L38x**

**Operating Mode: CPD/Color**

Index Label		M.I.	TIS		TIB	TIC	
			Scan	Non-scan			Non-scan
				A <sub>aprt</sub> ≤1	A <sub>aprt</sub> >1		
Global Maximum Index Value		1.3	1.0	—	—	(b)	
Associated Acoustic Parameter	P <sub>r.3</sub> (MPa)	2.89					
	W <sub>0</sub> (mW)		64.88	—	—	#	
	min of [W <sub>.3</sub> (z <sub>1</sub> ), I <sub>TA.3</sub> (z <sub>1</sub> )] (mW)				—		
	z <sub>1</sub> (cm)				—		
	z <sub>bp</sub> (cm)				—		
	z <sub>sp</sub> (cm)	1.1			—		
	d <sub>eq</sub> (z <sub>sp</sub> ) (cm)				—		
	f <sub>c</sub> (MHz)	4.91	4.91	—	—	#	
	Dim of A <sub>aprt</sub>	X (cm)		0.54	—	—	#
Y (cm)			0.4	—	—	#	
Other Information	PD (μsec)	0.529					
	PRF (Hz)	9547					
	p <sub>r</sub> @P <sub>II</sub> <sub>max</sub> (MPa)	3.48					
	d <sub>eq</sub> @P <sub>II</sub> <sub>max</sub> (cm)				—		
	Focal Length	FL <sub>x</sub> (cm)		1.5	—	—	#
		FL <sub>y</sub> (cm)		2.5	—	—	#
	I <sub>PA.3</sub> @M <sub>I</sub> <sub>max</sub> (W/cm <sup>2</sup> )	439.3					
Operating Control Conditions	Control 1: Mode	color	CPD				
	Control 2: Exam Type	Any	Bre				
	Control 3: PRF	331	2137				
	Control 4: Optimization/Depth	Any/3.1	Med/3.1				
	Control 5: Color Box Position/Size	Any	Def/ Def/ Def				

(a) This index is not required for this operating mode; value is <1.

(b) This transducer is not intended for transcranial or neonatal cephalic uses.

# No data are reported for this operating condition since the global maximum index value is not reported for the reason listed. (Reference Global Maximum Index Value line.)

— Data are not applicable for this transducer/mode.

**Table 27: Transducer Model: L38x**

**Operating Mode: PW Doppler**

Index Label		M.I.	TIS		TIB	TIC		
			Scan	Non-scan			Non-scan	
				$A_{aprt} \leq 1$	$A_{aprt} > 1$			
Global Maximum Index Value		1.04	—	2.0	—	2.6	(b)	
Associated Acoustic Parameter	$p_{r,3}$ (MPa)	2.345						
	$W_0$ (mW)		—	84.94		84.94	#	
	min of [ $W_{,3}(z_1), I_{TA,3}(z_1)$ ] (mW)				—			
	$z_1$ (cm)				—			
	$z_{bp}$ (cm)				—			
	$z_{sp}$ (cm)	0.8				1.3		
	$d_{eq}(z_{sp})$ (cm)					0.4685		
	$f_c$ (MHz)	5.01	—	5.05	—	5.05	#	
	Dim of $A_{aprt}$	X (cm)		—	1.80	—	1.80	#
Y (cm)			—	0.4	—	0.4	#	
Other Information	PD ( $\mu$ sec)	1.29						
	PRF (Hz)	1008						
	$p_r@PII_{max}$ (MPa)	2.693						
	$d_{eq}@PII_{max}$ (cm)					0.2533		
	Focal Length	FL <sub>x</sub> (cm)		—	5.54	—		#
		FL <sub>y</sub> (cm)		—	2.5	—		#
$I_{PA,3}@MI_{max}$ (W/cm <sup>2</sup> )	284.5							
Operating Control Conditions	Control 1: Exam Type		Any		Vas		Vas	
	Control 2: Sample Volume		1 mm		12 mm		12 mm	
	Control 3: PRF		1008		Any		Any	
	Control 4: Sample Volume Position		Zone 0 (top)		Zone 7		Zone 7	

(a) This index is not required for this operating mode; value is <1.

(b) This transducer is not intended for transcranial or neonatal cephalic uses.

# No data are reported for this operating condition since the global maximum index value is not reported for the reason listed. (Reference Global Maximum Index Value line.)

— Data are not applicable for this transducer/mode.

**Table 28: Transducer Model: L38xi/10-5**

**Operating Mode: 2D**

Index Label		M.I.	TIS			TIB	TIC	
			Scan	Non-scan		Non-scan		
				$A_{aprt} \leq 1$	$A_{aprt} > 1$			
Global Maximum Index Value		1.5	(a)	—	—	—	(b)	
Associated Acoustic Parameter	$p_{r,3}$ (MPa)	3.54						
	$W_0$ (mW)		#	—		—	#	
	min of [ $W_{.3}(z_1), I_{TA,3}(z_1)$ ] (mW)				—			
	$z_1$ (cm)				—			
	$z_{bp}$ (cm)				—			
	$z_{sp}$ (cm)	1.0				—		
	$d_{eq}(z_{sp})$ (cm)					—		
	$f_c$ (MHz)	5.76	#	—	—	—	#	
	Dim of $A_{aprt}$	X (cm)		#	—	—	—	#
Y (cm)			#	—	—	—	#	
Other Information	PD ( $\mu$ sec)	0.146						
	PRF (Hz)	7551						
	$p_r@PII_{max}$ (MPa)	4.32						
	$d_{eq}@PII_{max}$ (cm)					—		
	Focal Length	$FL_x$ (cm)		#	—	—		#
		$FL_y$ (cm)		#	—	—		#
$I_{PA,3}@MI_{max}$ ( $W/cm^2$ )	776							
Operating Control Conditions	Control 1: Exam Type		Any	—	—	—	—	
	Control 2: Optimization		Gen/Pen	—	—	—	—	
	Control 3: Depth		2.0 cm	—	—	—	—	
	Control 4: MB		On/Off	—	—	—	—	

(a) This index is not required for this operating mode; value is <1.

(b) This transducer is not intended for transcranial or neonatal cephalic uses.

#No data are reported for this operating condition since the global maximum index value is not reported for the reason listed. (Reference Global Maximum Index Value line.)

— Data are not applicable for this transducer/mode.

**Table 29: Transducer Model: L38xi/10-5**

**Operating Mode: M Mode**

Index Label		M.I.	TIS			TIB	TIC	
			Scan	Non-scan		Non-scan		
				$A_{aprt} \leq 1$	$A_{aprt} > 1$			
Global Maximum Index Value		1.5	—	(a)	—	1.2	(b)	
Associated Acoustic Parameter	$P_{r,3}$ (MPa)	3.54						
	$W_0$ (mW)		—	#		37.1	#	
	min of [ $W_{.3}(z_1), I_{TA,3}(z_1)$ ] (mW)				—			
	$z_1$ (cm)				—			
	$z_{bp}$ (cm)				—			
	$z_{sp}$ (cm)	1.0				0.9		
	$d_{eq}(z_{sp})$ (cm)					0.49		
	$f_c$ (MHz)	5.76	—	#	—	5.20	#	
	Dim of $A_{aprt}$	X (cm)		—	#	—	1.86	#
Y (cm)			—	#	—	0.40	#	
Other Information	PD ( $\mu$ sec)	0.146						
	PRF (Hz)	1600						
	$p_r@PII_{max}$ (MPa)	4.32						
	$d_{eq}@PII_{max}$ (cm)					0.49		
	Focal Length	$FL_x$ (cm)		—	#	—		#
		$FL_y$ (cm)		—	#	—		#
$I_{PA,3}@MI_{max}$ ( $W/cm^2$ )	776							
Operating Control Conditions	Control 1: Exam Type	Any	—	—	—	Any	—	
	Control 2: Optimization	Gen	—	—	—	Pen	—	
	Control 3: Depth	4.7 cm	—	—	—	7.3-9.0 cm	—	

(a) This index is not required for this operating mode; value is <1.

(b) This transducer is not intended for transcranial or neonatal cephalic uses.

#No data are reported for this operating condition since the global maximum index value is not reported for the reason listed. (Reference Global Maximum Index Value line.)

— Data are not applicable for this transducer/mode.



**Table 30: Transducer Model: L38xi/10-5**

**Operating Mode: CPD/Color**

Index Label		M.I.	TIS			TIB	TIC	
			Scan	Non-scan		Non-scan		
				$A_{aprt} \leq 1$	$A_{aprt} > 1$			
Global Maximum Index Value		1.5	1.1	—	—	—	(b)	
Associated Acoustic Parameter	$p_{r,3}$ (MPa)	3.30						
	$W_0$ (mW)		47.5	—	—	—	#	
	min of [ $W_3(z_1), I_{TA,3}(z_1)$ ] (mW)				—			
	$z_1$ (cm)				—			
	$z_{bp}$ (cm)				—			
	$z_{sp}$ (cm)	0.8						
	$d_{eq}(z_{sp})$ (cm)							
	$f_c$ (MHz)	4.82	4.82	—	—	—	#	
	Dim of $A_{aprt}$	X (cm)		0.66	—	—	—	#
Y (cm)			0.40	—	—	—	#	
Other Information	PD ( $\mu$ sec)	0.544						
	PRF (Hz)	2885						
	$p_r@PII_{max}$ (MPa)	3.79						
	$d_{eq}@PII_{max}$ (cm)					—		
	Focal Length	FL <sub>x</sub> (cm)		1.86	—	—		#
		FL <sub>y</sub> (cm)		1.50	—	—		#
$I_{PA,3}@MI_{max}$ (W/cm <sup>2</sup> )	605							
Operating Control Conditions	Control 1: Mode		CVD/CPD	CVD	—	—	—	—
	Control 2: Exam Type		Any	Bre	—	—	—	—
	Control 3: 2D Optimization/Depth		Any/2.0-2.5 cm	Any/3.8 cm	—	—	—	—
	Control 4: Color Optimization/PRF		Any/Any	Low/1323	—	—	—	—
	Control 5: Color Box Position/Size		Any/Any	Any/Default	—	—	—	—

(a) This index is not required for this operating mode; value is <1.

(b) This transducer is not intended for transcranial or neonatal cephalic uses.

#No data are reported for this operating condition since the global maximum index value is not reported for the reason listed. (Reference Global Maximum Index Value line.)

— Data are not applicable for this transducer/mode.

**Table 31: Transducer Model: L38xi/10-5**

**Operating Mode: PW Doppler**

Index Label		M.I.	TIS			TIB	TIC	
			Scan	Non-scan		Non-scan		
				$A_{aprt} \leq 1$	$A_{aprt} > 1$			
Global Maximum Index Value		1.1	—	2.6	—	3.7	(b)	
Associated Acoustic Parameter	$P_{r,3}$ (MPa)	2.56						
	$W_0$ (mW)		—	114.5		114.5	#	
	min of [ $W_{,3}(z_1), I_{TA,3}(z_1)$ ] (mW)				—			
	$z_1$ (cm)				—			
	$z_{bp}$ (cm)				—			
	$z_{sp}$ (cm)	1.19				0.8		
	$d_{eq}(z_{sp})$ (cm)					0.49		
	$f_c$ (MHz)	4.88	—	4.79	—	4.79	#	
	Dim of $A_{aprt}$	X (cm)		—	1.86	—	1.86	#
Y (cm)			—	0.40	—	0.40	#	
Other Information	PD ( $\mu$ sec)	1.22						
	PRF (Hz)	1008						
	$p_r@PII_{max}$ (MPa)	2.97						
	$d_{eq}@PII_{max}$ (cm)					0.45		
	Focal Length	$FL_x$ (cm)		—	5.54	—		#
		$FL_y$ (cm)		—	1.50	—		#
$I_{PA,3}@MI_{max}$ ( $W/cm^2$ )	342							
Operating Control Conditions	Control 1: Exam Type	Bre/Vas	—	Bre/Vas	—	Bre/Vas	—	
	Control 2: Sample Volume	1 mm	—	1 mm	—	1 mm	—	
	Control 3: PRF	1008	—	10417	—	10417	—	
	Control 4: Sample Volume Position	Zone 1	—	Zone 7	—	Zone 7	—	

(a) This index is not required for this operating mode; value is <1.

(b) This transducer is not intended for transcranial or neonatal cephalic uses.

#No data are reported for this operating condition since the global maximum index value is not reported for the reason listed. (Reference Global Maximum Index Value line.)

— Data are not applicable for this transducer/mode.

**Table 32: Transducer Model: P10x**

**Operating Mode: 2D Mode**

Index Label		M.I.	TIS		TIB	TIC		
			Scan	Non-scan			Non-scan	
				A <sub>aprt</sub> ≤1	A <sub>aprt</sub> >1			
Global Maximum Index Value		(a)	(a)	—	—	1.0		
Associated Acoustic Parameter	p <sub>r,3</sub> (MPa)	#						
	W <sub>0</sub> (mW)		#	—	—	35.24		
	min of [W <sub>3</sub> (z <sub>1</sub> ), I <sub>TA,3</sub> (z <sub>1</sub> )] (mW)				—			
	z <sub>1</sub> (cm)				—			
	z <sub>bp</sub> (cm)				—			
	z <sub>sp</sub> (cm)	#				—		
	d <sub>eq</sub> (z <sub>sp</sub> ) (cm)					—		
	f <sub>c</sub> (MHz)	#	#	—	—	—	4.84	
	Dim of A <sub>aprt</sub>	X (cm)		#	—	—	—	0.416
Y (cm)			#	—	—	—	0.7	
Other Information	PD (μsec)	#						
	PRF (Hz)	#						
	p <sub>r@PII<sub>max</sub></sub> (MPa)	#						
	d <sub>eq@PII<sub>max</sub></sub> (cm)					—		
	Focal Length	FL <sub>x</sub> (cm)		#	—	—	—	1.67
		FL <sub>y</sub> (cm)		#	—	—	—	5.0
I <sub>PA,3@MI<sub>max</sub></sub> (W/cm <sup>2</sup> )		#						
Operating Control Conditions	Control 1: Exam Type						Neo	
	Control 2: Optimization						Gen	
	Control 3: Depth						2.0	
	Control 4: MB/SonoHD						Off/Off	

(a) This index is not required for this operating mode; value is <1.

(b) This transducer is not intended for transcranial or neonatal cephalic uses.

# No data are reported for this operating condition since the global maximum index value is not reported for the reason listed. (Reference Global Maximum Index Value line.)

— Data are not applicable for this transducer/mode.

**Table 33: Transducer Model: P10x**

**Operating Mode: Color**

Index Label		M.I.	TIS		TIB	TIC	
			Scan	Non-scan			Non-scan
				$A_{aprt} \leq 1$	$A_{aprt} > 1$		
Global Maximum Index Value		1.0	(a)	—	—	1.3	
Associated Acoustic Parameter	$p_{r,3}$ (MPa)	2.02					
	$W_0$ (mW)		#	—	—	41.38	
	min of [ $W_3(z_1), I_{TA,3}(z_1)$ ] (mW)				—		
	$z_1$ (cm)				—		
	$z_{bp}$ (cm)				—		
	$z_{sp}$ (cm)	2.4			—		
	$d_{eq}(z_{sp})$ (cm)				—		
	$f_c$ (MHz)	3.90	#	—	—	3.91	
	Dim of $A_{aprt}$	X (cm)		#	—	—	0.608
Y (cm)			#	—	—	0.7	
Other Information	PD ( $\mu$ sec)	0.70					
	PRF (Hz)	2772					
	$p_r@PII_{max}$ (MPa)	2.80					
	$d_{eq}@PII_{max}$ (cm)				—		
	Focal Length	FL <sub>x</sub> (cm)		#	—	—	2.48
		FL <sub>y</sub> (cm)		#	—	—	5.0
$I_{PA,3}@MI_{max}$ (W/cm <sup>2</sup> )	252						
Operating Control Conditions	Control 1: Mode		Color			Color	
	Control 2: Exam Type		Neo			Abd	
	Control 3: Optimization/Depth/PRF		Low/ 3.7/ 772			Med/ 2.0/ 2315	
	Control 4: Color Box Pos/Size		Any/ Tall			Short/ Narrow	

(a) This index is not required for this operating mode; value is <1.

(b) This transducer is not intended for transcranial or neonatal cephalic uses.

# No data are reported for this operating condition since the global maximum index value is not reported for the reason listed. (Reference Global Maximum Index Value line.)

— Data are not applicable for this transducer/mode.

**Table 34: Transducer Model: P10x**

**Operating Mode: PW Doppler**

Index Label		M.I.	TIS		TIB	TIC		
			Scan	Non-scan			Non-scan	
				A <sub>aprt</sub> ≤1	A <sub>aprt</sub> >1			
Global Maximum Index Value		1.0	—	1.2	—	2.0	1.8	
Associated Acoustic Parameter	p <sub>r,3</sub> (MPa)	2.03						
	W <sub>0</sub> (mW)		—	36.25		34.4	31.5	
	min of [W <sub>3</sub> (z <sub>1</sub> ), I <sub>TA,3</sub> (z <sub>1</sub> )] (mW)				—			
	z <sub>1</sub> (cm)				—			
	z <sub>bp</sub> (cm)				—			
	z <sub>sp</sub> (cm)	2.1				0.8		
	d <sub>eq</sub> (z <sub>sp</sub> ) (cm)					0.32		
	f <sub>c</sub> (MHz)	3.87	—	6.86	—	3.84	3.86	
	Dim of A <sub>aprt</sub>	X (cm)		—	0.992	—	0.416	.224
Y (cm)			—	0.7	—	0.7	0.7	
Other Information	PD (μsec)	1.28						
	PRF (Hz)	1563						
	p <sub>r</sub> @PII <sub>max</sub> (MPa)	2.70						
	d <sub>eq</sub> @PII <sub>max</sub> (cm)					0.25		
	Focal Length	FL <sub>x</sub> (cm)		—	6.74	—		0.92
		FL <sub>y</sub> (cm)		—	5.0	—		5.0
I <sub>PA,3</sub> @MI <sub>max</sub> (W/cm <sup>2</sup> )		233						
Operating Control Conditions	Control 1: Exam Type	Crd		Crd		Neo	Crd	
	Control 2: Sample Volume	1 mm		7 mm		12 mm	1 mm	
	Control 3: PRF/TDI	1563/Off		Any/On		15625/Off	5208/Off	
	Control 4: Sample Volume Position	Zone 3		Zone 6		Zone 2	Zone 1	

(a) This index is not required for this operating mode; value is <1.

(b) This transducer is not intended for transcranial or neonatal cephalic uses.

# No data are reported for this operating condition since the global maximum index value is not reported for the reason listed. (Reference Global Maximum Index Value line.)

— Data are not applicable for this transducer/mode.

**Table 35: Transducer Model: P10x**

**Operating Mode: CW Doppler**

Index Label		M.I.	TIS			TIB	TIC	
			Scan	Non-scan		Non-scan		
				$A_{aprt} \leq 1$	$A_{aprt} > 1$			
Global Maximum Index Value		(a)	—	(a)	—	2.1	2.0	
Associated Acoustic Parameter	$p_{r,3}$ (MPa)	#						
	$W_0$ (mW)		—	#		40.72	30.00	
	min of [ $W_3(z_1), I_{TA,3}(z_1)$ ] (mW)				—			
	$z_1$ (cm)				—			
	$z_{bp}$ (cm)				—			
	$z_{sp}$ (cm)	#				0.7		
	$d_{eq}(z_{sp})$ (cm)					0.36		
	$f_c$ (MHz)	#	—	#	—	4.00	4.00	
	Dim of $A_{aprt}$	X (cm)		—	#	—	0.320	0.16
Y (cm)			—	#	—	0.7	0.7	
Other Information	PD ( $\mu$ sec)	#						
	PRF (Hz)	#						
	$p_r@PII_{max}$ (MPa)	#						
	$d_{eq}@PII_{max}$ (cm)					0.27		
	Focal Length	$FL_x$ (cm)		—	#	—		0.92
		$FL_y$ (cm)		—	#	—		5.0
$I_{PA,3}@MI_{max}$ ( $W/cm^2$ )		#						
Operating Control Conditions	Control 1: Exam Type					Card	Card	
	Control 2: Depth					Any	Any	
	Control 3: Zone					Zone 3	Zone 0	

(a) This index is not required for this operating mode; value is <1.

(b) This transducer is not intended for transcranial or neonatal cephalic uses.

# No data are reported for this operating condition since the global maximum index value is not reported for the reason listed. (Reference Global Maximum Index Value line.)

— Data are not applicable for this transducer/mode.

**Table 36: Transducer Model: P21x**

**Operating Mode: 2D**

Index Label		M.I.	TIS		TIB	TIC	
			Scan	Non-scan			Non-scan
				$A_{aprt} \leq 1$	$A_{aprt} > 1$		
Global Maximum Index Value		1.5	(a)	—	—	2.3	
Associated Acoustic Parameter	$P_{r,3}$ (MPa)	2.03					
	$W_0$ (mW)		#	—	—	171.53	
	min of [ $W_{,3}(z_1), I_{TA,3}(z_1)$ ] (mW)				—		
	$z_1$ (cm)				—		
	$z_{bp}$ (cm)				—		
	$z_{sp}$ (cm)	3.4			—		
	$d_{eq}(z_{sp})$ (cm)				—		
	$f_c$ (MHz)	1.83	#	—	—	—	1.94
	Dim of $A_{aprt}$	X (cm)		#	—	—	—
Y (cm)			#	—	—	—	1.3
Other Information	PD ( $\mu$ sec)	1.03					
	PRF (Hz)	4444					
	$p_r@PII_{max}$ (MPa)	2.53					
	$d_{eq}@PII_{max}$ (cm)				—		
	Focal Length	$FL_x$ (cm)		#	—	—	18.46
		$FL_y$ (cm)		#	—	—	9.0
$I_{PA,3}@MI_{max}$ ( $W/cm^2$ )		194					
Operating Control Conditions	Control 1: Exam Type		Card				Card
	Control 2: Optimization		Gen/ Pen				Pen
	Control 3: Depth		4.7 cm				27 cm
	Control 4: THI		On				Off
	Control 5: Sector Width		Any				Narrow

(a) This index is not required for this operating mode; value is <1.

(b) This transducer is not intended for transcranial or neonatal cephalic uses.

# No data are reported for this operating condition since the global maximum index value is not reported for the reason listed. (Reference Global Maximum Index Value line.)

— Data are not applicable for this transducer/mode.

**Table 37: Transducer Model: P21x**

**Operating Mode: M Mode**

Index Label		M.I.	TIS			TIB	TIC	
			Scan	Non-scan		Non-scan		
				$A_{aprt} \leq 1$	$A_{aprt} > 1$			
Global Maximum Index Value		1.5	—	(a)	—	1.4	1.1	
Associated Acoustic Parameter	$p_{r,3}$ (MPa)	2.10						
	$W_0$ (mW)		—	#		40.08	29.71	
	min of [ $W_{.3}(z_1), I_{TA.3}(z_1)$ ] (mW)				—			
	$z_1$ (cm)				—			
	$z_{bp}$ (cm)				—			
	$z_{sp}$ (cm)	3.645				4.9		
	$d_{eq}(z_{sp})$ (cm)					0.343		
	$f_c$ (MHz)	1.93	—	#	—	1.93	1.94	
	Dim of $A_{aprt}$	X (cm)		—	#	—	1.835	1.9
Y (cm)			—	#	—	1.3	1.3	
Other Information	PD ( $\mu$ sec)	0.904						
	PRF (Hz)	800						
	$p_r@PII_{max}$ (MPa)	2.679						
	$d_{eq}@PII_{max}$ (cm)					0.341		
	Focal Length	FL <sub>x</sub> (cm)		—	#	—		18.46
		FL <sub>y</sub> (cm)		—	#	—		5.5
$I_{PA.3}@MI_{max}$ (W/cm <sup>2</sup> )		237.4						
Operating Control Conditions	Control 1: Exam Type	Abd/OB				Abd/OB	Abd/OB /Card	
	Control 2: Optimization	Any				Gen/Res	Pen	
	Control 3: Depth	7.5 cm				10/13 cm	27 cm	
	Control 4: THI	On				On	Off	
	Control 5: MB	On				On or Off	On or Off	

(a) This index is not required for this operating mode; value is <1.

(b) This transducer is not intended for transcranial or neonatal cephalic uses.

# No data are reported for this operating condition since the global maximum index value is not reported for the reason listed. (Reference Global Maximum Index Value line.)

— Data are not applicable for this transducer/mode.



**Table 38: Transducer Model: P21x**

**Operating Mode: CPD/Color**

Index Label		M.I.	TIS			TIB	TIC	
			Scan	Non-scan		Non-scan		
				$A_{aprt} \leq 1$	$A_{aprt} > 1$			
Global Maximum Index Value		1.5	1.3	—	—	—	2.5	
Associated Acoustic Parameter	$p_{r,3}$ (MPa)	2.03						
	$W_0$ (mW)		136.91	—		—	116.5	
	min of $[W_{.3}(z_1), I_{TA,3}(z_1)]$ (mW)				—			
	$z_1$ (cm)				—			
	$z_{bp}$ (cm)				—			
	$z_{sp}$ (cm)	3.4				—		
	$d_{eq}(z_{sp})$ (cm)					—		
	$f_c$ (MHz)	1.83	2.16	—	—	—	2.17	
	Dim of $A_{aprt}$	X (cm)		0.918	—	—	—	0.46
Y (cm)			1.3	—	—	—	1.30	
Other Information	PD ( $\mu$ sec)	1.032						
	PRF (Hz)	2038						
	$p_r@PII_{max}$ (MPa)	2.53						
	$d_{eq}@PII_{max}$ (cm)					—		
	Focal Length	$FL_x$ (cm)		3.68	—	—		1.55
		$FL_y$ (cm)		9.00	—	—		9.00
$I_{PA,3}@MI_{max}$ (W/cm <sup>2</sup> )		194						
Operating Control Conditions	Control 1: Mode	Color	CPD				Color/CPD	
	Control 2: Exam Type	Crđ	OB				TCD	
	Control 3: PRF/Depth	Any/4.7	850/7.5				$\leq 2016/ 4.7$	
	Control 4: Color Optimization	Any	Med				Low	
	Control 5: THI	On	Off				Off	
	Control 6: Color Box Size	Any	Short and Narrow				Short and Narrow	

(a) This index is not required for this operating mode; value is <1.

(b) This transducer is not intended for transcranial or neonatal cephalic uses.

# No data are reported for this operating condition since the global maximum index value is not reported for the reason listed. (Reference Global Maximum Index Value line.)

— Data are not applicable for this transducer/mode.

**Table 39: Transducer Model: P21x**

**Operating Mode: PW Doppler**

Index Label		M.I.	TIS			TIB	TIC	
			Scan	Non-scan		Non-scan		
				$A_{aprt} \leq 1$	$A_{aprt} > 1$			
Global Maximum Index Value		1.2	—	—	1.3	4.0	2.8	
Associated Acoustic Parameter	$p_{r,3}$ (MPa)	1.73	—	—	—	—	—	
	$W_0$ (mW)	—	—	—	—	95.55	200.7	
	min of [ $W_{.3}(z_1), I_{TA.3}(z_1)$ ] (mW)	—	—	—	124.4	—	—	
	$z_1$ (cm)	—	—	—	3.1	—	—	
	$z_{bp}$ (cm)	—	—	—	2.8	—	—	
	$z_{sp}$ (cm)	5.0	—	—	—	0.6	—	
	$d_{eq}(z_{sp})$ (cm)	—	—	—	—	0.49	—	
	$f_c$ (MHz)	2.15	—	—	2.22	2.23	2.12	
	Dim of $A_{aprt}$	X (cm)	—	—	—	1.97	0.459	1.97
Y (cm)		—	—	—	1.3	1.3	1.30	
Other Information	PD ( $\mu$ sec)	1.182	—	—	—	—	—	
	PRF (Hz)	1562	—	—	—	—	—	
	$p_r@PII_{max}$ (MPa)	2.50	—	—	—	—	—	
	$d_{eq}@PII_{max}$ (cm)	—	—	—	—	0.49	—	
	Focal Length	$FL_x$ (cm)	—	—	—	13.84	—	18.46
		$FL_y$ (cm)	—	—	—	9.0	—	9.00
$I_{PA.3}@MI_{max}$ ( $W/cm^2$ )	( $W/cm^2$ )	216	—	—	—	—	—	
Operating Control Conditions	Control 1: Exam Type		Card	—	—	Card	TCD	Card
	Control 2: Sample Volume		1mm	—	—	3mm	14mm	1mm
	Control 3: PRF		1563	—	—	3906	12500	3125
	Control 4: Sample Volume Position		Zone 2	—	—	Zone 4	Zone 0	Zone 5

(a) This index is not required for this operating mode; value is <1.

(b) This transducer is not intended for transcranial or neonatal cephalic uses.

# No data are reported for this operating condition since the global maximum index value is not reported for the reason listed. (Reference Global Maximum Index Value line.)

— Data are not applicable for this transducer/mode.

**Table 40: Transducer Model: P21x**

**Operating Mode: CW Doppler**

Index Label		M.I.	TIS			TIB	TIC	
			Scan	Non-scan		Non-scan		
				A <sub>aprt</sub> ≤1	A <sub>aprt</sub> >1			
Global Maximum Index Value		(a)	—	—	1.0	3.5	3.0	
Associated Acoustic Parameter	p <sub>r,3</sub> (MPa)	#						
	W <sub>0</sub> (mW)		—	—		90.1	104.9	
	min of [W <sub>3</sub> (z <sub>1</sub> ), I <sub>TA,3</sub> (z <sub>1</sub> )] (mW)				104.9			
	z <sub>1</sub> (cm)				1.20			
	z <sub>bp</sub> (cm)				1.31			
	z <sub>sp</sub> (cm)	#				1.255		
	d <sub>eq</sub> (z <sub>sp</sub> ) (cm)					0.49		
	f <sub>c</sub> (MHz)	#	—	—	2.00	2.00	2.00	
	Dim of A <sub>aprt</sub>	X (cm)		—	—	0.46	0.655	0.459
Y (cm)			—	—	1.30	1.30	1.30	
Other Information	PD (μsec)	#						
	PRF (Hz)	#						
	p <sub>r</sub> @PII <sub>max</sub> (MPa)	#						
	d <sub>eq</sub> @PII <sub>max</sub> (cm)					0.45		
	Focal Length	FL <sub>x</sub> (cm)		—	—	1.55		1.55
		FL <sub>y</sub> (cm)		—	—	9.00		9.00
I <sub>PA,3</sub> @MI <sub>max</sub> (W/cm <sup>2</sup> )	#							
Operating Control Conditions	Control 1: Exam Type				Card	Card	Card	
	Control 2: Zone				Zone 0	Zone 1	Zone 0	

(a) This index is not required for this operating mode; value is <1.

(b) This transducer is not intended for transcranial or neonatal cephalic uses.

# No data are reported for this operating condition since the global maximum index value is not reported for the reason listed. (Reference Global Maximum Index Value line.)

— Data are not applicable for this transducer/mode.



**Table 41: Transducer Model: SLAx**

**Operating Mode: PW Doppler**

Index Label		M.I.	TIS		TIB	TIC		
			Scan	Non-scan			Non-scan	
				$A_{aprt} \leq 1$	$A_{aprt} > 1$			
Global Maximum Index Value		(a)	—	(a)	—	1.3	(b)	
Associated Acoustic Parameter	$P_{r,3}$ (MPa)	#						
	$W_0$ (mW)		—	#		11.3	#	
	min of [ $W_{,3}(z_1), I_{TA,3}(z_1)$ ] (mW)				—			
	$z_1$ (cm)				—			
	$z_{bp}$ (cm)				—			
	$z_{sp}$ (cm)	#				0.72		
	$d_{eq}(z_{sp})$ (cm)					0.15		
	$f_c$ (MHz)	#	—	#	—	6.00	#	
	Dim of $A_{aprt}$	X (cm)		—	#	—	0.32	#
		Y (cm)		—	#	—	0.30	#
Other Information	PD ( $\mu$ sec)	#						
	PRF (Hz)	#						
	$p_r@PII_{max}$ (MPa)	#						
	$d_{eq}@PII_{max}$ (cm)					0.14		
	Focal Length	$FL_x$ (cm)		—	#	—		#
		$FL_y$ (cm)		—	#	—		#
	$I_{PA,3}@MI_{max}$ ( $W/cm^2$ )	#						
Operating Control Conditions	Control 1: Exam Type					Vas, Nrv, Ven		
	Control 2: Sample Volume					6 mm		
	Control 3: PRF					20833		
	Control 4: Sample Vol. Position					Zone 2		

(a) This index is not required for this operating mode; value is <1.

(b) This transducer is not intended for transcranial or neonatal cephalic uses.

# No data are reported for this operating condition since the global maximum index value is not reported for the reason listed. (Reference Global Maximum Index Value line.)

— Data are not applicable for this transducer/mode.

**Table 42: Transducer Model: TEE<sub>x</sub>**

**Operating Mode: PW Doppler**

Index Label		M.I.	TIS			TIB	TIC	
			Scan	Non-scan		Non-scan		
				A <sub>aprt</sub> ≤1	A <sub>aprt</sub> >1			
Global Maximum Index Value		(a)	—	(a)	—	1.7	(b)	
Associated Acoustic Parameter	p <sub>r,3</sub> (MPa)	#						
	W <sub>0</sub> (mW)		—	#		29.29	#	
	min of [W <sub>.3</sub> (z <sub>1</sub> ), I <sub>TA,3</sub> (z <sub>1</sub> )] (mW)				—			
	z <sub>1</sub> (cm)				—			
	z <sub>bp</sub> (cm)				—			
	z <sub>sp</sub> (cm)	#				0.6		
	d <sub>eq</sub> (z <sub>sp</sub> ) (cm)					0.34		
	f <sub>c</sub> (MHz)	#	—	#	—	3.84	#	
	Dim of A <sub>aprt</sub>	X (cm)		—	#	—	0.261	#
Y (cm)			—	#	—	0.9	#	
Other Information	PD (μsec)	#						
	PRF (Hz)	#						
	p <sub>r</sub> @P <sub>II</sub> <sub>max</sub> (MPa)	#						
	d <sub>eq</sub> @P <sub>II</sub> <sub>max</sub> (cm)					0.34		
	Focal Length	FL <sub>x</sub> (cm)		—	#	—		#
		FL <sub>y</sub> (cm)		—	#	—		#
I <sub>PA,3</sub> @M <sub>I</sub> <sub>max</sub> (W/cm <sup>2</sup> )	#							
Operating Control Conditions	Control 1: Exam Type					Crd		
	Control 2: Sample Volume					1 mm		
	Control 3: PRF					≥ 2604		
	Control 4: Sample Volume Position					Zone 1		

(a) This index is not required for this operating mode; value is <1.

(b) This transducer is not intended for transcranial or neonatal cephalic uses.

# No data are reported for this operating condition since the global maximum index value is not reported for the reason listed. (Reference Global Maximum Index Value line.)

— Data are not applicable for this transducer/mode.

**Table 43: Transducer Model: TEE<sub>x</sub>**

**Operating Mode: CW Doppler**

Index Label		M.I.	TIS			TIB	TIC	
			Scan	Non-scan		Non-scan		
				$A_{aprt} \leq 1$	$A_{aprt} > 1$			
Global Maximum Index Value		(a)	—	(a)	—	1.2	(b)	
Associated Acoustic Parameter	$P_{r,3}$ (MPa)	#						
	$W_0$ (mW)		—	#		27.23	#	
	min of [ $W_{.3}(z_1), I_{TA,3}(z_1)$ ] (mW)				—			
	$z_1$ (cm)				—			
	$z_{bp}$ (cm)				—			
	$z_{sp}$ (cm)	#				1.1		
	$d_{eq}(z_{sp})$ (cm)					0.39		
	$f_c$ (MHz)	#	—	#	—	4.00	#	
	Dim of $A_{aprt}$	X (cm)		—	#	—	0.435	#
Y (cm)			—	#	—	0.9	#	
Other Information	PD ( $\mu$ sec)	#						
	PRF (Hz)	#						
	$P_r@PII_{max}$ (MPa)	#						
	$d_{eq}@PII_{max}$ (cm)					0.34		
	Focal Length	FL <sub>x</sub> (cm)		—	#	—		#
		FL <sub>y</sub> (cm)		—	#	—		#
$I_{PA,3}@MI_{max}$ (W/cm <sup>2</sup> )		#						
Operating Control Conditions	Control 1: Exam Type					Crd		
	Control 2: Depth					Any		
	Control 3: Zone					Zone 3		

(a) This index is not required for this operating mode; value is <1.

(b) This transducer is not intended for transcranial or neonatal cephalic uses.

# No data are reported for this operating condition since the global maximum index value is not reported for the reason listed. (Reference Global Maximum Index Value line.)

— Data are not applicable for this transducer/mode.

## Terms used in the acoustic output tables

**Table 44: Acoustic Output Terms and Definitions**

<b>Term</b>	<b>Definition</b>
<b><math>I_{SPTA,3}</math></b>	Derated spatial peak, temporal average intensity in units of milliwatts/cm <sup>2</sup> .
<b>TI type</b>	Applicable thermal index for the transducer, imaging mode, and exam type.
<b>TI value</b>	Thermal index value for the transducer, imaging mode, and exam type.
<b>MI</b>	Mechanical index.
<b><math>I_{pa,3}@MI_{max}</math></b>	Derated pulse average intensity at the maximum MI in units of W/cm <sup>2</sup> .
<b>TIS</b>	(Soft tissue thermal index) is a thermal index related to soft tissues. TIS scan is the soft tissue thermal index in an auto-scanning mode. TIS non-scan is the soft tissue thermal index in the non-autoscanning mode.
<b>TIB</b>	(Bone thermal index) is a thermal index for applications in which the ultrasound beam passes through soft tissue and a focal region is in the immediate vicinity of bone. TIB non-scan is the bone thermal index in the non-autoscanning mode.
<b>TIC</b>	(Cranial bone thermal index) is the thermal index for applications in which the ultrasound beam passes through bone near the beam entrance into the body.
<b><math>A_{aprt}</math></b>	Area of the active aperture measured in cm <sup>2</sup> .
<b><math>P_{r,3}</math></b>	Derated peak rarefactional pressure associated with the transmit pattern giving rise to the value reported under MI (Megapascals).
<b>Wo</b>	Ultrasonic power, except for $TIS_{scan}$ , in which case it is the ultrasonic power passing through a one centimeter window in units of milliwatts.
<b><math>W_{,3}(z_1)</math></b>	Derated ultrasonic power at axial distance $z_1$ in units of milliwatts.
<b><math>I_{SPTA,3}(z_1)</math></b>	Derated spatial-peak temporal-average intensity at axial distance $z_1$ (milliwatts per square centimeter).
<b><math>z_1</math></b>	Axial distance corresponding to the location of maximum $[\min(W_{,3}(z), I_{TA,3}(z) \times 1 \text{ cm}^2)]$ , where $z \geq z_{bp}$ in centimeters.
<b><math>z_{bp}</math></b>	$1.69 \sqrt{(A_{aprt})}$ in centimeters.
<b><math>z_{sp}</math></b>	For MI, the axial distance at which $p_{r,3}$ is measured. For TIB, the axial distance at which TIB is a global maximum (for example, $z_{sp} = z_{b,3}$ ) in centimeters.



**Table 44: Acoustic Output Terms and Definitions (Continued)**

<b>Term</b>	<b>Definition</b>
<b><math>d_{eq}(z)</math></b>	Equivalent beam diameter as a function of axial distance $z$ , and is equal to $\sqrt{(4/(\pi))(W_0)/(I_{TA}(z))}$ , where $I_{TA}(z)$ is the temporal-average intensity as a function of $z$ in centimeters.
<b><math>fc</math></b>	Center frequency in MHz.
<b>Dim. of <math>A_{aprt}</math></b>	Active aperture dimensions for the azimuthal (x) and elevational (y) planes in centimeters.
<b>PD</b>	Pulse duration (microseconds) associated with the transmit pattern giving rise to the reported value of MI.
<b>PRF</b>	Pulse repetition frequency associated with the transmit pattern giving rise to the reported value of MI in Hertz.
<b><math>p_r@PII_{max}</math></b>	Peak rarefactional pressure at the point where the free-field, spatial-peak pulse intensity integral is a maximum in Megapascals.
<b><math>d_{eq}@PII_{max}</math></b>	Equivalent beam diameter at the point where the free-field, spatial-peak pulse intensity integral is a maximum in centimeters.
<b>FL</b>	Focal length, or azimuthal (x) and elevational (y) lengths, if different measured in centimeters.

### Acoustic measurement precision and uncertainty

All table entries have been obtained at the same operating conditions that give rise to the maximum index value in the first column of the table. Measurement precision and uncertainty for power, pressure, intensity, and other quantities that are used to derive the values in the acoustic output table are shown in the table below. In accordance with Section 6.4 of the Output Display Standard, the following measurement precision and uncertainty values are determined by making repeat measurements and stating the standard deviation as a percentage.







**Table 45: Acoustic Measurement Precision and Uncertainty**

Quantity	Precision (% of standard deviation)	Uncertainty (95% confidence)
Pr	1.9%	±11.2%
Pr <sub>3</sub>	1.9%	±12.2%
Wo	3.4%	±10%
fc	0.1%	±4.7%
Pll	3.2%	+12.5 to -16.8%
Pll <sub>3</sub>	3.2%	+13.47 to -17.5%













## Labeling symbols

The following symbols are used on the products, packaging, and containers.













**Table 46: Labeling Symbols**

Symbol	Definition
	Alternating Current (AC)
	Class 1 device indicating manufacturer's declaration of conformance with Annex VII of 93/42/EEC
	Class 1 device requiring verification by the Notified Body of sterilization or measurement features, or to a Class IIa, IIb, or III device requiring verification or auditing by the Notified Body to applicable Annex(es) of 93/42/EEC
	Attention, see the user guide
	Device complies with relevant Australian regulations for electronic devices.
	Batch code, date code, or lot code type of control number
	Biological risk





**Table 46: Labeling Symbols (Continued)**

Symbol	Definition
	Device complies with relevant Brazilian regulations for electro-medical devices.
	Canadian Standards Association. The "C" and "US" indicators next to this mark signify that the product has been evaluated to the applicable CSA and ANSI/UL Standards, for use in Canada and the US, respectively.
	Catalog number
	Collect separately from other household waste (see European Commission Directive 93/86/EEC). Refer to local regulations for disposal.
	Corrugated recycle
	Dangerous voltage
	Date of manufacture
	Direct Current (DC)
	Do not get wet.
	Do not stack over 2 high.
	Do not stack over 5 high.
	Do not stack over 10 high.





**Table 46: Labeling Symbols (Continued)**

Symbol	Definition
	Electrostatic sensitive devices
	Device complies with relevant FCC regulations for electronic devices.
	Fragile
GEL	Gel
	Sterilized using irradiation
	Sterilized using ethylene oxide
	Hot
	Device emits a static (DC) magnetic field.
	Non-ionizing radiation
	Paper recycle
	Serial number type of control number
	Temperature limitation
	Atmospheric pressure limitations

**Table 46: Labeling Symbols (Continued)**

Symbol	Definition
	Humidity limitation
IPX7	Submersible. Protected against the effects of temporary immersion.
IPX8	Water-Tight Equipment. Protected against the effects of extended immersion.
	Handle transducer with care.
	Follow manufacturer's instructions for disinfecting time.
	Disinfect transducer.
	Type BF patient applied part (B = body, F = floating applied part)
	Defibrillator proof type CF patient applied part
	Underwriter's Laboratories labeling
	Pollution Control Logo. (Applies to all parts/products listed in the China RoHS disclosure table. May not appear on the exterior of some parts/products because of space limitations.)
	China Compulsory Certificate mark ("CCC Mark"). A compulsory safety mark for compliance to Chinese national standards for many products sold in the People's Republic of China.
	Temperature limitation.
	Atmospheric pressure limitation.

**Table 46: Labeling Symbols (Continued)**

<b>Symbol</b>	<b>Definition</b>
	Humidity limitation.
	Attention, see the user guide.
	Follow instructions for use.
	Manufacturer, or Manufacturer and date of manufacture
	Authorized representative in the European Community
WARNING: Connect Only Accessories and Peripherals Recommended by SonoSite	WARNING: Connect Only Accessories and Peripherals Recommended by SonoSite

# Chapter 7: References

## Measurement accuracy

The measurements provided by the system do not define a specific physiological or anatomical parameter. Rather, the measurements are of a physical property such as distance for evaluation by the clinician. The accuracy values require that you can place the calipers over one pixel. The values do not include acoustic anomalies of the body.

The 2D linear distance measurement results are displayed in centimeters with one place past the decimal point, if the measurement is ten or greater; two places past the decimal point, if the measurement is less than ten.

The linear distance measurement components have the accuracy and range shown in the following tables.

**Table 1: 2D Measurement Accuracy and Range**

2D Measure Accuracy and Range	System Tolerance <sup>a</sup>	Accuracy By	Test Method <sup>b</sup>	Range (cm)
Axial Distance	< ±2% plus 1% of full scale	Acquisition	Phantom	0-26 cm
Lateral Distance	< ±2% plus 1% of full scale	Acquisition	Phantom	0-35 cm
Diagonal Distance	< ±2% plus 1% of full scale	Acquisition	Phantom	0-44 cm
Area <sup>c</sup>	< ±4% plus (2% of full scale/smallest dimension) * 100 plus 0.5%	Acquisition	Phantom	0.01-720 cm <sup>2</sup>
Circumference <sup>d</sup>	< ±3% plus (1.4% of full scale/smallest dimension) * 100 plus 0.5%	Acquisition	Phantom	0.01-96 cm

- Full scale for distance implies the maximum depth of the image.
- An RMI 413a model phantom with 0.7 dB/cm MHz attenuation was used.
- The area accuracy is defined using the following equation:  

$$\% \text{ tolerance} = ((1 + \text{lateral error}) * (1 + \text{axial error}) - 1) * 100 + 0.5\%$$
- The circumference accuracy is defined as the greater of the lateral or axial accuracy and by the following equation:  

$$\% \text{ tolerance} = (\sqrt{2} (\text{maximum of 2 errors}) * 100) + 0.5\%$$

**Table 2: M Mode Measurement and Calculation Accuracy and Range**

M Mode Measurement Accuracy and Range	System Tolerance	Accuracy By	Test Method	Range
Distance	< +/- 2% plus 1% of full scale <sup>a</sup>	Acquisition	Phantom <sup>b</sup>	0-26 cm
Time	< +/- 2% plus 1% of full scale <sup>c</sup>	Acquisition	Phantom <sup>d</sup>	0.01-10 sec
Heart Rate	< +/- 2% plus (Full Scale <sup>c</sup> * Heart Rate/100) %	Acquisition	Phantom <sup>d</sup>	5-923 bpm

- Full scale for distance implies the maximum depth of the image.
- An RMI 413a model phantom with 0.7 dB/cm MHz attenuation was used.
- Full scale for time implies the total time displayed on the scrolling graphic image.
- SonoSite special test equipment was used.

**Table 3: PW Doppler Mode Measurement and Calculation Accuracy and Range**

Doppler Mode Measurement Accuracy and Range	System Tolerance	Accuracy By	Test Method <sup>a</sup>	Range
Velocity cursor	< +/- 2% plus 1% of full scale <sup>b</sup>	Acquisition	Phantom	0.01 cm/sec-550 cm/sec
Frequency cursor	< +/- 2% plus 1% of full scale <sup>b</sup>	Acquisition	Phantom	0.01 kHz-20.8 kHz
Time	< +/- 2% plus 1% of full scale <sup>c</sup>	Acquisition	Phantom	0.01-10 sec

- SonoSite special test equipment was used.
- Full scale for frequency or velocity implies the total frequency or velocity magnitude, displayed on the scrolling graphic image.
- Full scale for time implies the total time displayed on the scrolling graphic image.

## Sources of measurement errors

In general, two types of errors can be introduced into the measurement:

**Acquisition Error** Includes errors introduced by the ultrasound system electronics relating to signal acquisition, signal conversion, and signal processing for display. Additionally, computational and display errors are introduced by the generation of the pixel scale factor, application of that factor to the caliper positions on the screen, and the measurement display.

**Algorithmic Error** The error introduced by measurements, which are input to higher order calculations. This error is associated with



floating-point versus integer-type math, which is subject to errors introduced by rounding versus truncating results for display of a given level of significant digit in the calculation.

## Measurement publications and terminology

The following sections list the publications and terminology used for each calculation result.

Terminology and measurements comply with AIUM published standards.

### Cardiac references

#### Acceleration (ACC) in cm/s<sup>2</sup>

Zwiebel, W.J. *Introduction to Vascular Ultrasonography*. 4th ed., W.B. Saunders Company, (2000), 52.

ACC = abs (delta velocity/delta time)

#### Acceleration Time (AT) in msec

Oh, J.K., J.B. Seward, A.J. Tajik. *The Echo Manual*. 2nd ed., Lippincott, Williams, and Wilkins, (1999), 219.

#### Aortic Valve Area (AVA) by Continuity Equation in cm<sup>2</sup>

Reynolds, Terry. *The Echocardiographer's Pocket Reference*. 2nd ed., School of Cardiac Ultrasound, Arizona Heart Institute, (2000), 393, 442.

$$A_2 = A_1 * V_1/V_2$$

where:  $A_2$  = Ao valve area  
 $A_1$  = LVOT area;  $V_1$  = LVOT velocity;  
 $V_2$  = Ao valve velocity  
LVOT = Left Ventricular Outflow Tract

$$AVA (PV_{LVOT}/PV_{AO}) * CSA_{LVOT}$$

$$AVA (VTI_{LVOT}/VTI_{AO}) * CSA_{LVOT}$$

#### Body Surface Area (BSA) in m<sup>2</sup>

Grossman, W. *Cardiac Catheterization and Angiography*. Philadelphia: Lea and Febiger, (1980), 90.

$$BSA = 0.007184 * Weight^{0.425} * Height^{0.725}$$

Weight = kilograms

Height = centimeters

#### Cardiac Index (CI) in l/min/m<sup>2</sup>

Oh, J.K., J.B. Seward, A.J. Tajik. *The Echo Manual*. 2nd Edition, Boston: Little, Brown and Company, (1999), 59.

$$CI = CO/BSA$$

where: CO = Cardiac Output  
BSA = Body Surface Area

#### Cardiac Output (CO) in l/min

Oh, J.K., J.B. Seward, A.J. Tajik *The Echo Manual*. 2nd ed., Lippincott, Williams, and Wilkins, (1999), 59.

$$CO = (SV * HR)/1000$$

where: CO = Cardiac Output  
SV = Stroke Volume  
HR = Heart Rate

#### Cross Sectional Area (CSA) in cm<sup>2</sup>

Reynolds, Terry. *The Echocardiographer's Pocket Reference*. 2nd ed., School of Cardiac Ultrasound, Arizona Heart Institute, (2000), 383.

$$CSA = 0.785 * D^2$$

where: D = diameter of the anatomy of interest

#### Deceleration Time in msec

Reynolds, Terry. *The Echocardiographer's Pocket Reference*. 2nd ed., School of Cardiac Ultrasound, Arizona Heart Institute, (2000), 453.

$$|time a - time b|$$

## **Delta Pressure: Delta Time (dP:dT) in mmHg/s**

Otto, C.M. *Textbook of Clinical Echocardiography*. 2nd ed., W.B. Saunders Company, (2000), 117, 118.

32 mmHg/time interval in seconds

## **E:A Ratio in cm/sec**

E:A = velocity E/velocity A

## **E/Ea Ratio**

Reynolds, Terry. *The Echocardiographer's Pocket Reference*. 2nd ed., School of Cardiac Ultrasound, Arizona Heart Institute, (2000), 225.

E Velocity/Ea velocity

where: E velocity = Mitral Valve E velocity  
Ea = annular E velocity, also known as: E prime

## **Effective Regurgitant Orifice (ERO) in mm<sup>2</sup>**

Reynolds, Terry. *The Echocardiographer's Pocket Reference*. 2nd ed., School of Cardiac Ultrasound, Arizona Heart Institute, (2000), 455.

$ERO = 6.28 (r^2) * Va / MR Vel$

where: r = radius  
Va = aliasing velocity

## **Ejection Fraction (EF), percent**

Oh, J.K., J.B. Seward, A.J. Tajik. *The Echo Manual*. 2nd ed., Lippincott, Williams, and Wilkins, (1999), 40.

$EF = ((LVEDV - LVESV) / LVEDV) * 100\%$

where: EF = Ejection Fraction  
LVEDV = Left Ventricular End Diastolic Volume  
LVESV = Left Ventricular End Systolic Volume

## **Elapsed Time (ET) in msec**

ET = time between velocity cursors in milliseconds

## **Heart Rate (HR) in bpm**

HR = 3 digit value input by user or measured on M Mode and Doppler image in one heart cycle

## **Interventricular Septum (IVS) Fractional Thickening, percent**

Laurenceau, J. L., M.C. Malergue. *The Essentials of Echocardiography*. Le Hague: Martinus Nijhoff, (1981), 71.

$IVSFT = ((IVSS - IVSD) / IVSD) * 100\%$

where: IVSS = Interventricular Septal Thickness at Systole  
IVSD = Interventricular Septal Thickness at Diastole

## **Isovolumic Relaxation Time (IVRT) in msec**

Reynolds, Terry. *The Echocardiographer's Pocket Reference*. School of Cardiac Ultrasound, Arizona Heart Institute, (1993), 146.

|time a - time b|

## **Left Atrium/Aorta (LA/Ao)**

Feigenbaum, H. *Echocardiography*. Philadelphia: Lea and Febiger, (1994), 206, Figure 4-49.

## **Left Ventricular End Volumes (Teichholz) in ml**

Teichholz, L.E., T. Kreulen, M.V. Herman, et. al. "Problems in echocardiographic volume determinations: echocardiographic-angiographic correlations in the presence or absence of asynergy." *American Journal of Cardiology*, (1976), 37:7.

$LVESV = (7.0 * LVDS^3) / (2.4 + LVDS)$

where: LVESV = Left Ventricular End Systolic Volume

LVDS = Left Ventricular Dimension at Systole

$$LVEDV = (7.0 * LVDD^3)/(2.4 + LVDD)$$

where: LVEDV = Left Ventricular End Diastolic Volume

LVDD = Left Ventricular Dimension at Diastole

### Left Ventricular Mass in gm

Oh, J.K., J.B. Seward, A.J. Tajik. *The Echo Manual*. 2nd Edition, Boston: Little, Brown and Company, (1999), 39.

$$LV \text{ Mass} = 1.04 [(LVID + PWT + IVST)^3 - LVID^3] * 0.8 + 0.6$$

where: LVID = Internal Dimension  
PWT = Posterior Wall Thickness  
IVST = Interventricular Septal Thickness  
1.04 = Specific gravity of the myocardium  
0.8 = Correction factor

### Left Ventricular Volume: Biplane Method in ml

N.B., P.M. Shah, M. Crawford, et.al. "Recommendations for Quantitation of the Left Ventricle by Two-Dimensional Echocardiography." *Journal of American Society of Echocardiography*. September-October 1989, 2:362.

$$V = \left(\frac{\pi}{4}\right) \sum_{i=1}^n a_i b_i \left(\frac{L}{n}\right)$$

where: V = Volume in ml  
a = Diameter  
b = Diameter  
n = Number of segments (n=20)  
L = Length  
i = Segment

### Left Ventricular Volume: Single Plane Method in ml

N.B., P.M. Shah, M. Crawford, et.al. "Recommendations for Quantitation of the Left Ventricle by Two-Dimensional Echocardiography." *Journal of American Society of Echocardiography*. September-October 1989, 2:362.

$$V = \left(\frac{\pi}{4}\right) \sum_{i=1}^n a_i^2 \left(\frac{L}{n}\right)$$

where: V = Volume  
a = Diameter  
n = Number of segments (n=20)  
L = Length  
i = Segment

### Left Ventricular Dimension (LVD) Fractional Shortening, percent

Oh, J.K., J.B. Seward, A.J. Tajik. *The Echo Manual*. Boston: Little, Brown and Company, (1994), 43-44.

$$LVDFS = ((LVDD - LVDS)/LVDD) * 100\%$$

where: LVDD = Left Ventricle Dimension at Diastole  
LVDS = Left Ventricle Dimension at Systole

### Left Ventricular Posterior Wall Fractional Thickening (LVPWFT), percent

Laurenceau, J. L., M.C. Malergue. *The Essentials of Echocardiography*. Le Hague: Martinus Nijhoff, (1981), 71.

$$LVPWFT = ((LVPWS - LVPWD)/LVPWD) * 100\%$$

where: LVPWS = Left Ventricular Posterior Wall Thickness at Systole  
LVPWD = Left Ventricular Posterior Wall Thickness at Diastole

### Mean Velocity (Vmean) in cm/s

Vmean = mean velocity

### **Mitral Valve Area (MVA) in cm<sup>2</sup>**

Reynolds, Terry. *The Echocardiographer's Pocket Reference*. 2nd ed., School of Cardiac Ultrasound, Arizona Heart Institute, (2000), 391, 452.

$$MVA = 220/PHT$$

where: PHT = pressure half time

*Note: 220 is an empirical derived constant and may not accurately predict mitral valve area in mitral prosthetic heart valves. The mitral valve area continuity equation may be utilized in mitral prosthetic heart valves to predict effective orifice area.*

### **MV Flow Rate in cc/sec**

Reynolds, Terry. *The Echocardiographer's Pocket Reference*. 2nd ed., School of Cardiac Ultrasound, Arizona Heart Institute, (2000), 396.

$$\text{Flow} = 6.28 (r^2) * Va$$

where: r = radius

Va = aliasing Velocity

### **Pressure Gradient (PGr) in mmHG**

Oh, J.K., J.B. Seward, A.J. Tajik. *The Echo Manual*. 2nd ed., Lippincott, Williams, and Wilkins, (1999), 64.

$$PGr = 4 * (\text{Velocity})^2$$

Peak E Pressure Gradient (E PG)

$$E PG = 4 * PE^2$$

Peak A Pressure Gradient (A PG)

$$A PG = 4 * PA^2$$

Peak Pressure Gradient (PGmax)

$$PGmax = 4 * PV^2$$

Mean Pressure Gradient (PGmean)

PGmean = Average of pressure gradients/Duration of flow

### **Pressure Half Time (PHT) in msec**

Reynolds, Terry. *The Echocardiographer's Pocket Reference*. 2nd ed., School of Cardiac Ultrasound, Arizona Heart Institute, (2000), 391.

$$PHT = DT * 0.29$$

where: DT = deceleration time

### **Proximal Isovelocity Surface Area (PISA) in cm<sup>2</sup>**

Oh, J.K., J.B. Seward, A.J. Tajik. *The Echo Manual*. 2nd ed., Boston: Little, Brown and Company, (1999), 125.

$$PISA = 2\pi r^2$$

where:  $2\pi = 6.28$

r = aliasing radius

### **Qp/Qs**

Reynolds, Terry. *The Echocardiographer's Pocket Reference*. 2nd ed., School of Cardiac Ultrasound, Arizona Heart Institute, (2000), 400.

$$Qp/Qs = SV Qp \text{ site} / SV Qs \text{ site}$$

SV sites will vary depending upon the location of the shunt.

### **Regurgitant Fraction (RF) in percent**

Oh, J.K., J.B. Seward, A.J. Tajik. *The Echo Manual*. Boston: Little, Brown and Company, (1999), 125.

$$RF = RV / MV SV$$

where: RV = Regurgitant Volume

MV SV = Mitral Stroke Volume

### **Regurgitant Volume (RV) in cc**

Reynolds, Terry. *The Echocardiographer's Pocket Reference*. School of Cardiac Ultrasound, Arizona Heart Institute, (2000), 396, 455.

$$RV = ERO * MR VTI$$

## Right Ventricular Systolic Pressure (RVSP) in mmHg

Reynolds, Terry. *The Echocardiographer's Pocket Reference*. School of Cardiac Ultrasound, Arizona Heart Institute, (1993), 152.

$$RVSP = 4 * (V_{max} TR)^2 + RAP$$

where: RAP = Right Atrial Pressure

## S/D

Reynolds, Terry. *The Echocardiographer's Pocket Reference*. 2nd ed., School of Cardiac Ultrasound, Arizona Heart Institute, (2000), 217.

S velocity/ D velocity

where: S velocity = Pulmonary vein S wave  
D velocity = Pulmonary vein D wave

## Stroke Index (SI) in cc/m<sup>2</sup>

*Mosby's Medical, Nursing, & Allied Health Dictionary*, 4th ed., (1994), 1492.

$$SI = SV/BSA$$

where: SV = Stroke Volume  
BSA = Body Surface Area

## Stroke Volume (SV) Doppler in ml

Oh, J.K., J.B. Seward, A.J. Tajik. *The Echo Manual*. 2nd ed., Lippincott, Williams, and Wilkins, (1999), 40, 59, 62.

$$SV = (CSA * VTI)$$

where CSA = Cross Sectional Area of the orifice (LVOT area)  
VTI = Velocity Time Integral of the aortic valve

## Tricuspid Valve Area (TVA)

Reynolds, Terry. *The Echocardiographer's Pocket Reference*. 2nd ed., School of Cardiac Ultrasound, Arizona Heart Institute, (2000), 55, 391, 452.

$$TVA = 220 / PHT$$

## Stroke Volume (SV) 2D and M Mode in ml

Oh, J.K., J.B. Seward, A.J. Tajik. *The Echo Manual*. 2nd ed., Boston: Little, Brown and Company, (1994), 44.

$$SV = (LVEDV - LVESV)$$

where: SV = Stroke Volume  
LVEDV = End Diastolic Volume  
LVESV = End Systolic Volume

## Velocity Time Integral (VTI) in cm

Reynolds, Terry. *The Echocardiographer's Pocket Reference*. 2nd ed., School of Cardiac Ultrasound, Arizona Heart Institute, (2000), 383.

VTI = sum of abs (velocities [n])

where: Auto Trace – distance (cm) blood travels with each ejection period.  
Velocities are absolute values.

## Obstetrical references

### Amniotic Fluid Index (AFI)

Jeng, C. J., et al. "Amniotic Fluid Index Measurement with the Four Quadrant Technique During Pregnancy." *The Journal of Reproductive Medicine*, 35:7 (July 1990), 674-677.

### Average Ultrasound Age (AUA)

The system provides an AUA derived from the component measurements from the measurement tables.

### Estimated Date of Delivery (EDD) by Average Ultrasound Age (AUA)

Results are displayed as month/day/year.

$$EDD = \text{system date} + (280 \text{ days} - \text{AUA in days})$$

### Estimated Date of Delivery (EDD) by Last Menstrual Period (LMP)

The date entered into the patient information for LMP must precede the current date.

Results are displayed as month/day/year.

EDD = LMP date + 280 days

### **Estimated Fetal Weight (EFW)**

Hadlock, F., et al. "Estimation of Fetal Weight with the Use of Head, Body, and Femur Measurements, A Prospective Study." *American Journal of Obstetrics and Gynecology*, 151:3 (February 1, 1985), 333-337.

Hansmann, M., et al. *Ultrasound Diagnosis in Obstetrics and Gynecology*. New York: Springer-Verlag, (1986), 154.

Osaka University. *Ultrasound in Obstetrics and Gynecology*. (July 20, 1990), 103-105.

Shepard M.J., V. A. Richards, R. L. Berkowitz, et al. "An Evaluation of Two Equations for Predicting Fetal Weight by Ultrasound." *American Journal of Obstetrics and Gynecology*, 142:1 (January 1, 1982), 47-54.

University of Tokyo, Shinozuka, N. FJSUM, et al. "Standard Values of Ultrasonographic Fetal Biometry." *Japanese Journal of Medical Ultrasonics*, 23:12 (1996), 880, Equation 1.

### **Gestational Age (GA) by Last Menstrual Period (LMP)**

The gestational age derived from the LMP date entered on the patient information form.

Results are displayed in weeks and days, and is calculated as follows:

$GA(LMP) = \text{System date} - \text{LMP date}$

### **Gestational Age (GA) by Last Menstrual Period (LMPd) Derived from Established Due Date (Estab. DD)**

Same as GA by Estab. DD.

The gestational age derived from the system derived LMP using the Established Due Date entered on the patient information form.

Results are displayed in weeks and days, and is calculated as follows:

$GA(LMPd) = \text{System Date} - \text{LMPd}$

### **Last Menstrual Period Derived (LMPd) by Established Due Date (Estab. DD)**

Results are displayed as month/day/year.

$LMPd(\text{Estab. DD}) = \text{Estab. DD} - 280 \text{ days}$

## **Gestational age tables**

### **Abdominal Circumference (AC)**

Hadlock, F., et al. "Estimating Fetal Age: Computer-Assisted Analysis of Multiple Fetal Growth Parameters." *Radiology*, 152: (1984), 497-501.

Hansmann, M., et al. *Ultrasound Diagnosis in Obstetrics and Gynecology*. New York: Springer-Verlag, (1986), 431.

University of Tokyo, Shinozuka, N. FJSUM, et al. "Standard Values of Ultrasonographic Fetal Biometry." *Japanese Journal of Medical Ultrasonics*, 23:12 (1996), 885.

#### **WARNING:**

The gestational age calculated by your SonoSite system does not match the age in the aforementioned reference at the 20.0 cm and 30.0 cm abdominal circumference (AC) measurements. The implemented algorithm extrapolates the gestational age from the slope of the curve of all table measurements, rather than decreasing the gestational age for a larger AC measurement indicated in the referenced table. This results in the gestational age always increasing with an increase in AC.

### **Biparietal Diameter (BPD)**

Chitty, L. S. and D.G. Altman. "New charts for ultrasound dating of pregnancy." *Ultrasound in Obstetrics and Gynecology* 10: (1997), 174-179, Table 3.

Hadlock, F., et al. "Estimating Fetal Age: Computer-Assisted Analysis of Multiple Fetal Growth Parameters." *Radiology*, 152: (1984), 497-501.

Hansmann, M., et al. *Ultrasound Diagnosis in Obstetrics and Gynecology*. New York: Springer-Verlag, (1986), 440.

Osaka University. *Ultrasound in Obstetrics and Gynecology*. (July 20, 1990), 98.

University of Tokyo, Shinozuka, N. FJSUM, et al. "Standard Values of Ultrasonographic Fetal Biometry." *Japanese Journal of Medical Ultrasonics*, 23:12 (1996), 885.

### **Cisterna Magna (CM)**

Mahony, B.; P. Callen, R. Filly, and W. Hoddick. "The fetal cisterna magna." *Radiology*, 153: (December 1984), 773-776.

### **Crown Rump Length (CRL)**

Hadlock, F., et al. "Fetal Crown-Rump Length: Re-evaluation of Relation to Menstrual Age (5-18 weeks) with High-Resolution, Real-Time Ultrasound." *Radiology*, 182: (February 1992), 501-505.

Hansmann, M., et al. *Ultrasound Diagnosis in Obstetrics and Gynecology*. New York: Springer-Verlag, (1986), 439.

Osaka University. *Ultrasound in Obstetrics and Gynecology*. (July 20, 1990), 20 and 96.

Tokyo University. "Gestational Weeks and Computation Methods." *Ultrasound Imaging Diagnostics*, 12:1 (1982-1), 24-25, Table 3.

### **Femur Length (FL)**

Chitty, L. S. and D.G. Altman. "New charts for ultrasound dating of pregnancy." *Ultrasound in Obstetrics and Gynecology* 10: (1997), 174-179, Table 8, 186.

Hadlock, F., et al. "Estimating Fetal Age: Computer-Assisted Analysis of Multiple Fetal Growth Parameters." *Radiology*, 152: (1984), 497-501.

Hansmann, M., et al. *Ultrasound Diagnosis in Obstetrics and Gynecology*. New York: Springer-Verlag, (1986), 431.

Osaka University. *Ultrasound in Obstetrics and Gynecology*. (July 20, 1990), 101-102.

University of Tokyo, Shinozuka, N. FJSUM, et al. "Standard Values of Ultrasonographic Fetal Biometry." *Japanese Journal of Medical Ultrasonics*, 23:12 (1996), 886.

### **Fetal Trunk Cross-Sectional Area (FTA)**

Osaka University. *Ultrasound in Obstetrics and Gynecology*. (July 20, 1990), 99-100.

### **Gestational Sac (GS)**

Hansmann, M., et al. *Ultrasound Diagnosis in Obstetrics and Gynecology*. New York: Springer-Verlag, (1986).

Nyberg, D.A., et al. "Transvaginal Ultrasound." *Mosby Yearbook*, (1992), 76.

Gestational sac measurements provide a fetal age based on the mean of one, two, or three distance measurements; however, Nyberg's gestational age equation requires all three distance measurements for an accurate estimate.

Tokyo University. "Gestational Weeks and Computation Methods." *Ultrasound Imaging Diagnostics*, 12:1 (1982-1).

### **Head Circumference (HC)**

Chitty, L. S. and D.G. Altman. "New charts for ultrasound dating of pregnancy." *Ultrasound in Obstetrics and Gynecology* 10: (1997), 174-191, Table 5, 182.

Hadlock, F., et al. "Estimating Fetal Age: Computer-Assisted Analysis of Multiple Fetal Growth Parameters." *Radiology*, 152: (1984), 497-501.

Hansmann, M., et al. *Ultrasound Diagnosis in Obstetrics and Gynecology*. New York: Springer-Verlag, (1986), 431.

### **Humerus (HL)**

Jeanty, P.; F. Rodesch; D. Delbeke; J. E. Dumont. "Estimate of Gestational Age from Measurements of Fetal Long Bones." *Journal of Ultrasound in Medicine*. 3: (February 1984), 75-79

### **Occipito-Frontal Diameter (OFD)**

Hansmann, M., et al. *Ultrasound Diagnosis in Obstetrics and Gynecology*. New York: Springer-Verlag, (1986), 431.

### **Tibia**

Jeanty, P.; F. Rodesch; D. Delbeke; J. E. Dumont. "Estimate of Gestational Age from Measurements of Fetal Long Bones." *Journal of Ultrasound in Medicine*. 3: (February 1984), 75-79

### **Transverse Trunk Diameter (TTD)**

Hansmann, M., et al. *Ultrasound Diagnosis in Obstetrics and Gynecology*. New York: Springer-Verlag, (1986), 431.

## **Growth analysis tables**

### **Abdominal Circumference (AC)**

Chitty, Lyn S. et al. "Charts of Fetal Size: 3. Abdominal Measurements." *British Journal of Obstetrics and Gynaecology* 101: (February 1994), 131, Appendix: AC-Derived.

Hadlock, F., et al. "Estimating Fetal Age: Computer-Assisted Analysis of Multiple Fetal Growth Parameters." *Radiology*, 152: (1984), 497-501.

Jeanty P., E. Cousaert, and F. Cantraine. "Normal Growth of the Abdominal Perimeter." *American Journal of Perinatology*, 1: (January 1984), 129-135.

(Also published in Hansmann, Hackeloer, Staudach, Wittman. *Ultrasound Diagnosis in Obstetrics and Gynecology*. Springer-Verlag, New York, (1986), 179, Table 7.13.)

### **Biparietal Diameter (BPD)**

Chitty, Lyn S. et al. "Charts of Fetal Size: 2. Head Measurements." *British Journal of Obstetrics and Gynaecology* 101: (January 1994), 43, Appendix: BPD-Outer-Inner.

Hadlock, F., et al. "Estimating Fetal Age: Computer-Assisted Analysis of Multiple Fetal Growth Parameters." *Radiology*, 152: (1984), 497-501.

Jeanty P., E. Cousaert, and F. Cantraine. "A Longitudinal Study of Fetal Limb Growth." *American Journal of Perinatology*, 1: (January 1984), 136-144, Table 5.

(Also published in Hansmann, Hackeloer, Staudach, Wittman. *Ultrasound Diagnosis in Obstetrics and Gynecology*. Springer-Verlag, New York, (1986), 176, Table 7.8.)

### **Estimated Fetal Weight (EFW)**

Brenner, William E.; D. A. Edelman; C. H. Hendricks. "A standard of fetal growth for the United States of America," *American Journal of Obstetrics and Gynecology*, 126: 5 (November 1, 1976), 555-564; Table II.

Hadlock F., et al. "In Utero Analysis of Fetal Growth: A Sonographic Weight Standard." *Radiology*, 181: (1991), 129-133.

Jeanty, Philippe, F. Cantraine, R. Romero, E. Cousaert, and J. Hobbins. "A Longitudinal Study of Fetal Weight Growth." *Journal of Ultrasound in Medicine*, 3: (July 1984), 321-328, Table 1.

(Also published in Hansmann, Hackeloer, Staudach, and Wittman. *Ultrasound Diagnosis*



in *Obstetrics and Gynecology*. Springer-Verlag, New York, (1986), 186, Table 7.20.)

### **Femur Length (FL)**

Chitty, Lyn S. et al. "Charts of Fetal Size: 4. Femur Length." *British Journal of Obstetrics and Gynaecology* 101: (February 1994), 135.

Hadlock, F., et al. "Estimating Fetal Age: Computer-Assisted Analysis of Multiple Fetal Growth Parameters." *Radiology*, 152: (1984), 497-501.

Jeanty P, E. Cousaert, and F. Cantraine. "A Longitudinal Study of Fetal Limb Growth." *American Journal of Perinatology*, 1: (January 1984), 136-144, Table 5.

(Also published in Hansmann, Hackeloer, Staudach, Wittman. *Ultrasound Diagnosis in Obstetrics and Gynecology*. Springer-Verlag, New York, (1986), 182, Table 7.17.)

### **Head Circumference (HC)**

Chitty, Lyn S., et al. "Charts of Fetal Size: 2. Head Measurements." *British Journal of Obstetrics and Gynaecology* 101: (January 1994), 43, Appendix: HC-Derived.

Hadlock, F., et al. "Estimating Fetal Age: Computer-Assisted Analysis of Multiple Fetal Growth Parameters." *Radiology*, 152: (1984), 497-501.

Jeanty P, E. Cousaert, and F. Cantraine. "A longitudinal study of Fetal Head Biometry." *American J of Perinatology*, 1: (January 1984), 118-128, Table 3.

(Also published in Hansmann, Hackeloer, Staudach, Wittman. *Ultrasound Diagnosis in Obstetrics and Gynecology*. Springer-Verlag, New York, (1986), 176, Table 7.8.)

### **Head Circumference (HC)/Abdominal Circumference (AC)**

Campbell S., Thoms Alison. "Ultrasound Measurements of the Fetal Head to Abdomen Circumference Ratio in the Assessment of Growth Retardation," *British Journal of Obstetrics and Gynaecology*, 84: (March 1977), 165-174.

## **Ratio calculations**

### **FL/AC Ratio**

Hadlock F.P., R. L. Deter, R. B. Harrist, E. Roecker, and S.K. Park. "A Date Independent Predictor of Intrauterine Growth Retardation: Femur Length/Abdominal Circumference Ratio," *American Journal of Roentgenology*, 141: (November 1983), 979-984.

### **FL/BPD Ratio**

Hohler, C.W., and T.A. Quetel. "Comparison of Ultrasound Femur Length and Biparietal Diameter in Late Pregnancy," *American Journal of Obstetrics and Gynecology*, 141:7 (Dec. 1 1981), 759-762.

### **FL/HC Ratio**

Hadlock F.P., R. B. Harrist, Y. Shah, and S. K. Park. "The Femur Length/Head Circumference Relation in Obstetric Sonography." *Journal of Ultrasound in Medicine*, 3: (October 1984), 439-442.

### **HC/AC Ratio**

Campbell S., Thoms Alison. "Ultrasound Measurements of the Fetal Head to Abdomen Circumference Ratio in the Assessment of Growth Retardation," *British Journal of Obstetrics and Gynaecology*, 84: (March 1977), 165-174.

## General references

### +/x or S/D Ratio

$+/x = \text{abs}(\text{Velocity A}/\text{Velocity B})$

where        A = velocity cursor +  
                  B = velocity cursor x

### Acceleration Index (ACC)

Zwiebel, W.J. *Introduction to Vascular Ultrasonography*, 4th ed., W.B. Saunders Company, (2000), 52.

$\text{ACC} = \text{abs}(\text{delta velocity}/\text{delta time})$

### Elapsed Time (ET)

ET = time between velocity cursors in milliseconds

### Hip Angle/d:D Ratio

Graf, R. "Fundamentals of Sonographic Diagnosis of Infant Hip Dysplasia." *Journal of Pediatric Orthopedics*, Vol. 4, No. 6: 735-740, 1984.

Morin, C., Harcke, H., MacEwen, G. "The Infant Hip: Real-Time US Assessment of Acetabular Development." *Radiology* 177: 673-677, December 1985.

### Intima Media Thickness (IMT)

Howard G, Sharrett AR, Heiss G, Evans GW, Chambless LE, Riley WA, et al. "Carotid Artery Intima-Medial Thickness Distribution in General Populations As Evaluated by B-Mode Ultrasound." ARIC Investigators. Atherosclerosis Risk in Communities. *Stroke*. (1993), 24:1297-1304.

O'Leary, Daniel H., MD and Polak, Joseph, F., MD, et al. "Use of Sonography to Evaluate Carotid Atherosclerosis in the Elderly. The Cardiovascular Health Study." *Stroke*. (September 1991), 22,1155-1163.

Redberg, Rita F., MD and Vogel, Robert A., MD, et al. "Task force #3—What is the Spectrum of Current and Emerging Techniques for the

Noninvasive Measurement of Atherosclerosis?" *Journal of the American College of Cardiology*. (June 4, 2003), 41:11, 1886-1898.

### Percent Area Reduction

Taylor K.J.W., P.N. Burns, P. Breslau. *Clinical Applications of Doppler Ultrasound*, Raven Press, N.Y., (1988), 130-136.

Zwiebel W.J., J.A. Zagzebski, A.B. Crummy, et al. "Correlation of peak Doppler frequency with lumen narrowing in carotid stenosis." *Stroke*, 3: (1982), 386-391.

$\% \text{ Area Reduction} = (1 - \text{A2}(\text{cm}^2)/\text{A1}(\text{cm}^2)) * 100$

where:        A1 = original area of the vessel in square cm  
                  A2 = reduced area of the vessel in square cm

### Percent Diameter Reduction

Handa, Nobuo et al., "Echo-Doppler Velocimeter in the Diagnosis of Hypertensive Patients: The Renal Artery Doppler Technique," *Ultrasound in Medicine and Biology*, 12:12 (1986), 945-952.

$\% \text{ Diameter Reduction} = (1 - \text{D2}(\text{cm})/\text{D1}(\text{cm})) * 100$

where:        D1 = original diameter of the vessel in cm  
                  D2 = reduced diameter of the vessel in cm

### Pressure Gradient (PGr) in mmHG

Oh, J.K., J.B. Seward, A.J. Tajik. *The Echo Manual*. 2nd ed., Lippincott, Williams, and Wilkins, (1999), 64.

$4 * (\text{Velocity})^2$

Peak E Pressure Gradient (E PG)

$\text{E PG} = 4 * \text{PE}^2$

Peak A Pressure Gradient (A PG)

$\text{A PG} = 4 * \text{PA}^2$

Peak Pressure Gradient (PGmax)

$$PG_{\max} = 4 * PV^2$$

Mean Pressure Gradient (PG<sub>mean</sub>)

$$PG_{\text{mean}} = 4 * V_{\max}^2$$

### **Pulsatility Index (PI)**

Kurtz, A.B., W.D. Middleton. *Ultrasound-the Requisites*. Mosby Year Book, Inc., (1996), 469.

$$PI = (PSV - EDV)/V$$

where PSV = peak systolic velocity  
EDV = end diastolic velocity  
V = mean flow velocity throughout the entire cardiac cycle

### **Resistive Index (RI)**

Kurtz, A.B., W.D. Middleton. *Ultrasound-the Requisites*. Mosby Year Book, Inc., (1996), 467.

RI = abs ((Velocity A – Velocity B)/Velocity A) in measurements

where A = velocity cursor +  
B = velocity cursor x

### **Time Averaged Mean (TAM) in cm/s**

TAM = mean (mean Trace)

### **Time Averaged Peak (TAP) in cm/s**

TAP = peak (peak Trace)

### **Volume (Vol)**

Beyer, W.H. *Standard Mathematical Tables*, 28th ed., CRC Press, Boca Raton, FL, (1987), 131.

Volume cm<sup>3</sup> = (4/3) \* Length/2 \* Width/2 \* Height/2

### **Volume Flow (VF) in ml/m**

Allan, Paul L. et al. *Clinical Doppler Ultrasound*, 4th ed., Harcourt Publishers Limited. (2000), 36-38.

One of the following, depending on the Live Trace setting:

$$VF = CSA * TAM * .06$$

$$VF = CSA * TAP * .06$$



# Chapter 8: Specifications

This chapter contains system and accessory specifications and standards. The specifications for recommended peripherals are in the manufacturers' instructions.

## Dimensions

### System

**Length:** 11.8 in. (29.97 cm)

**Width:** 10.8 in. (27.43 cm)

**Height:** 3.1 in. (7.87 cm)

**Weight:** 8.5 lbs. (3.9 kg) with the C60x transducer and battery installed

### Display

**Length:** 8.4 in. (21.34 cm)

**Height:** 6.3 in. (16 cm)

**Diagonal:** 10.4 in. (26.4 cm)

## Supported transducers

- C11x/8-5 MHz (6 ft/1.8 m)
- C60x/5-2 MHz (5.5 ft/1.7 m)
- D2x/2 MHz (5.5 ft/1.7 m)
- HFL38x/13-6 MHz (5.5 ft/1.7 m)
- HFL50x/15-6 MHz (5.5 ft/1.7 m)
- ICTx/8-5 MHz (5.7 ft/1.7 m)
- L25x/13-6 MHz (7.5 ft/2.3 m)
- L38x/10-5 MHz (5.5 ft/1.7 m)
- L38xi/10-5 MHz (5.5 ft/1.7 m)
- P10x/8-4 MHz (6 ft/1.8 m)
- P21x/5-1 MHz (6 ft/1.8 m)

- SLAx/13-6 MHz (7.5 ft/2.3 m)
- TEEEx/8-3 MHz (11.8 ft./3.6 m)

## Imaging modes

- 2D (256 gray shades)
- Color power Doppler (CPD) (256 colors)
- Color Doppler (Color) (256 colors)
- M Mode
- Pulsed wave (PW) Doppler
- Continuous wave (CW) Doppler
- Tissue Doppler Imaging (TDI)
- Tissue Harmonic Imaging (THI)

## Image and clip storage

Internal storage: The number of images and clips you can save depends on imaging mode and file format.

## Accessories

The following items are either included with or available for use on the ultrasound system:

- Battery
- Biopsy Guide
- Carry case
- ECG cable (6 ft/1.8 m)
- Education keys
- External display
- Footswitch
- Mini-Dock

- Mobile docking system
- Needle Guide
- Power supply
- SiteLink Image Manager
- SonoCalc IMT
- System AC power cord (10 ft/3.1 m)
- Triple Transducer Connect

## Peripherals

See the manufacturer's specifications for the following peripherals.

### Medical grade

- Bar code scanner, serial
- Bar code scanner, USB
- Black-and-white printer

Recommended sources for printer paper:  
Contact Sony at 800-686-7669 or  
[www.sony.com/professional](http://www.sony.com/professional) to order supplies  
or to find the local distributor.

- Color printer
- DVD recorder

### Non-medical grade

- Kensington security cable
- USB storage device Temperature and humidity limits

*Note: The temperature, pressure, and humidity limits apply only to the ultrasound system, transducers, and battery.*

## Operating

### System, battery, and transducer

10–40°C (50–104°F), 15–95% R.H.

700 to 1060hPa (0.7 to 1.05 ATM)

## Shipping and storage

### System and transducer

-35–65°C (-31–149°F), 15–95% R.H.

500 to 1060hPa (0.5 to 1.05 ATM)

### Battery

-20–60°C (-4–140°F), 15–95% R.H. (For storage longer than 30 days, store at or below room temperature.)

500 to 1060hPa (0.5 to 1.05 ATM)

## Electrical

Power Supply Input: 100-240 VAC, 50/60 Hz, 2.0 A Max @ 100 VAC

Power Supply Output #1: 15 VDC, 5.0 A Max

Power Supply Output #2: 12 VDC, 2.3 A Max

Combined output not exceeding 75 watts.

## Battery

The battery comprises six lithium-ion cells plus electronics, a temperature sensor, and battery contacts.

Run time is up to two hours, depending on imaging mode and display brightness.

## Standards

### Electromechanical safety standards

CAN/CSA C22.2, No. 60601-1:08, Medical Electrical Equipment - Part 1: General Requirements for Basic Safety and Essential Performance.

IEC 60601-1:1988, International Electrotechnical Commission, Medical Electrical Equipment-Part 1. General Requirements for Safety (2nd Edition including Amendment 1 and 2).

IEC 60601-1:2012, Medical electrical equipment - Part 1: General requirements for basic safety and essential performance [Edition 3.1].

IEC 60601-2-37:2001, International Electrotechnical Commission, Particular Requirements for the Safety of Ultrasonic Medical Diagnostic and Monitoring Equipment.

IEC 60601-2-37:2007, Medical electrical equipment - Part 2-37: Particular requirements for the basic safety and essential performance of ultrasonic medical diagnostic and monitoring equipment.

IEC 61157, International Electrotechnical Commission, Standard Means for the Reporting of the Acoustic Output of Medical Diagnostic Ultrasonic Equipment. EMC standards classification

IEC 60601-1-2:2007, Medical electrical equipment - Part 1-2: General requirements for basic safety and essential performance - Collateral standard: Electromagnetic compatibility - Requirements and tests.

CISPR 11, International Electrotechnical Commission, International Special Committee on Radio Interference. Industrial, Scientific, and Medical (ISM) Equipment - Radio-Frequency Disturbance Characteristics-Limits and Methods of Measurement. Classification for the ultrasound system, docking system, accessories, and peripherals when configured together: Group 1, Class A.

## Acoustic standards

NEMA UD 2-2004, Acoustic Output Measurement Standard for Diagnostic Ultrasound Equipment.

NEMA UD 3-2004, Standard for Real-Time Display of Thermal and Mechanical Acoustic Output Indices on Diagnostic Ultrasound Equipment, American Institute of Ultrasound in Medicine.

## Biocompatibility standards

AAMI/ANSI/ISO 10993-1, Biological evaluation of medical devices - Part 1: Evaluation and testing (2009).

## Airborne equipment standards

RTCA/DO-160E, Radio Technical Commission for Aeronautics, Environmental Conditions and Test Procedures for Airborne Equipment, Section 21.0 Emission of Radio Frequency Energy, Category B.118.

## DICOM standard

NEMA PS 3.15, Digital Imaging and Communications in Medicine (DICOM)-Part 15: Security and System Management Profiles.

## HIPAA standard 45 CFR 160, General Administrative Requirements.

45 CFR 164, Security and Privacy.





# Glossary

## Terms

For ultrasound terms not included in this glossary, refer to *Recommended Ultrasound Terminology, Second Edition*, published in 1997 by the American Institute of Ultrasound in Medicine (AIUM).

<b>as low as reasonably achievable (ALARA)</b>	The guiding principle of ultrasound use, which states that you should keep patient exposure to ultrasound energy as low as reasonably achievable for diagnostic results.
<b>curved array transducer</b>	Identified by the letter C (curved or curvilinear) and a number (60). The number corresponds to the radius of curvature of the array expressed in millimeters. The transducer elements are electrically configured to control the characteristics and direction of the acoustic beam. For example, C15, C60e.
<b>depth</b>	Refers to the depth of the display. A constant speed of sound of 1538.5 meters/second is assumed in the calculation of echo position in the image.
<b><i>in situ</i></b>	In the natural or original position.
<b>LCD</b>	liquid crystal display
<b>linear array transducer</b>	Identified by the letter L (linear) and a number (38). The number corresponds to the radius of width of the array expressed in millimeters. The transducer elements are electrically configured to control the characteristics and direction of the acoustic beam. For example, L38.
<b>mechanical index (MI)</b>	An indication of the likelihood of mechanical bioeffects occurring: the higher the MI, the greater the likelihood of mechanical bioeffects. See <a href="#">Chapter 6, "Safety,"</a> for a more complete description of MI.
<b>MI/TI</b>	See <i>mechanical index (MI)</i> and <i>thermal index (TI)</i> .
<b>NTSC</b>	National Television Standards Committee. A video format setting. See also <i>PAL</i> .
<b>PAL</b>	Phase Alternating Line. A video format setting. See also <i>NTSC</i> .
<b>phased array</b>	A transducer designed primarily for cardiac scanning. Forms a sector image by electronically steering the beam direction and focus.

<b>skinline</b>	A depth on the display that corresponds to the skin/transducer interface.
<b>SonoHD™ Imaging Technology</b>	A subset of the 2D imaging mode in which the 2D image is enhanced by reducing speckle noise artifact at tissue margins and improving contrast resolution by reducing artifacts and improving visualization of texture patterns within the image.
<b>SonoMB technology</b>	A subset of the 2D imaging mode in which the 2D image is enhanced by looking at a target from multiple angles and then merging or averaging the scanned data together to improve overall image quality and, in parallel, reducing noise and artifacts.
<b>Tissue Doppler Imaging (TDI)</b>	A pulsed wave Doppler technique used to detect myocardial motion.
<b>thermal index (TI)</b>	The ratio of total acoustic power to the acoustic power required to raise tissue temperature by 1°C under defined assumptions. See <a href="#">Chapter 6, "Safety,"</a> for a more complete description of TI.
<b>TIB (bone thermal index)</b>	A thermal index for applications in which the ultrasound beam passes through soft tissue and a focal region is in the immediate vicinity of bone.
<b>TIC (cranial bone thermal index)</b>	A thermal index for applications in which the ultrasound beam passes through bone near the beam entrance into the body.
<b>TIS (soft tissue thermal index)</b>	A thermal index related to soft tissues.
<b>Tissue Harmonic Imaging</b>	Transmits at one frequency and receives at a higher harmonic frequency to reduce noise and clutter and improve resolution.
<b>transducer</b>	A device that transforms one form of energy into another form of energy. Ultrasound transducers contain piezoelectric elements, which when excited electrically, emit acoustic energy. When the acoustic energy is transmitted into the body, it travels until it encounters an interface, or change in tissue properties. At the interface, an echo is formed that returns to the transducer, where this acoustic energy is transformed into electrical energy, processed, and displayed as anatomical information.
<b>variance</b>	Displays a variation in Color Doppler flow imaging within a given sample. Variance is mapped to the color green and is used to detect turbulence.

# Abbreviations

## Abbreviations in User Interface

Abbreviation	Definition
+/x	"+" Caliper/"x" Caliper Ratio
A	"A" Wave Peak Velocity
A PG	"A" Wave Peak Pressure Gradient
A2Cd	Apical 2 Chamber diastolic
A2Cs	Apical 2 Chamber systolic
A4Cd	Apical 4 Chamber diastolic
A4Cs	Apical 4 Chamber systolic
AAA	Abdominal Aortic Aneurysm
AAo	Ascending Aorta
Abd	Abdomen
abs	Absolute value
AC	Abdominal Circumference
ACA	Anterior Cerebral Artery
ACC	Acceleration Index
ACoA	Anterior Communicating Artery
ACS	Aortic Valve Cusp Separation
Adur	"A" wave duration
AFI	Amniotic Fluid Index
AI	Aortic Insufficiency
AI PHT	Aortic Insufficiency Pressure Half Time
AL	Atlas Loop
Ann D	Annulus Diameter
ANT F	Anterior Far
ANT N	Anterior Near

## Abbreviations in User Interface (Continued)

<b>Abbreviation</b>	<b>Definition</b>
Ao	Aorta
AoD	Aortic Root Diameter
Apical	Apical View
APTD	Anteroposterior Trunk Diameter
AT	Acceleration (Deceleration) Time
AUA	Average Ultrasound Age Calculated by averaging the individual ultrasound ages for the fetal biometry measurements performed during the exam. The measurements used to determine the AUA are based on the selected OB calculation authors.
AV	Aortic Valve
AV Area	Aortic Valve Area
AVA	Aortic Valve Area
BA	Basilar Artery
Bifur	Bifurcation
BP	Blood Pressure
BPD	Biparietal Diameter
BPM	Beats per Minute
Bre	Breast
BSA	Body Surface Area
CCA	Common Carotid Artery
CI	Cardiac Index
CM	Cisterna Magna
CO	Cardiac Output
CPD	Color Power Doppler
Crd	Cardiac
CRL	Crown Rump Length

## Abbreviations in User Interface (Continued)

Abbreviation	Definition
CW	Continuous Wave Doppler
CxLen	Cervix Length
D	Diameter
D Apical	Distance Apical
DCCA	Distal Common Carotid Artery
DECA	Distal External Carotid Artery
DICA	Distal Internal Carotid Artery
Dist	Distal
dP:dT	Delta Pressure: Delta Time
E	"E" Wave Peak Velocity
E PG	"E" Wave Peak Pressure Gradient
E:A	E:A Ratio
E/e'	E velocity = Mitral Valve E velocity divided by the annular e' velocity
ECA	External Carotid Artery
ECG	Electrocardiogram
ECICA	Extracranial Internal Carotid Artery
ECVA	Extracranial Vertebral Artery
EDD	Estimated Date of Delivery
EDD by AUA	Estimated Date of Delivery by Average Ultrasound Age The estimated date of delivery calculated from the measurements performed during the exam.
EDD by LMP	Estimated Date of Delivery by Last Menstrual Period The due date calculated from the user-entered LMP.
EDV	End Diastolic Velocity
EF	Ejection Fraction
EF:SLOPE	E-F Slope

## Abbreviations in User Interface (Continued)

<b>Abbreviation</b>	<b>Definition</b>
EFW	Estimated Fetal Weight Calculated from the measurements performed during the exam. The measurements used to determine EFW are defined by the currently selected EFW calculation author.
Endo	Endocardial
Epi	Epicardial
EPSS	"E" Point Septal Separation
Estab. DD	Established Due Date A user-entered due date based on previous exam data or other available information. The LMP is derived from the Established Due Date and is listed in the patient report as LMPd.
ET	Elapsed Time
FH	Femoral Head
FHR	Fetal Heart Rate
FL	Femur Length
FM (Right and Left)	Foramen Magnum (same as SO)
FTA	Fetal Trunk Area
GA	Gestational Age
GA by LMP	Gestational Age by Last Menstrual Period The fetal age calculated using the date of the Last Menstrual Period (LMP).
GA by LMPd	Gestational Age by derived Last Menstrual Period The fetal age calculated using the Last Menstrual Period (LMPd) derived from the Estab. DD.
Gate	Depth of Doppler Gate
GS	Gestational Sac
Gyn	Gynecology
HC	Head Circumference
HL	Humerus Length

## Abbreviations in User Interface (Continued)

<b>Abbreviation</b>	<b>Definition</b>
HR	Heart Rate
ICA	Internal Carotid Artery
IMT	Intima Media Thickness
IVRT	Iso Volumic Relaxation Time
IVS	Interventricular Septum
IVSd	Interventricular Septum Diastolic
IVSFT	Interventricular Septum Fractional Thickening
IVSs	Interventricular Septum Systolic
LA	Left Atrium
LA/Ao	Left Atrium/Aorta Ratio
LAT F	Lateral Far
LAT N	Lateral Near
Lat V	Lateral Ventricle
LMP	Last Menstrual Period
LMP	Last Menstrual Period The first day of the last menstrual period. Used to calculate gestational age and EDD.
LMPd	derived Last Menstrual Period Calculated from the user-entered Estab. DD.
LV	Left Ventricular
LV Area	Left Ventricular Area
LV mass	Left Ventricular mass
LV Volume	Left Ventricular Volume
LVd	Left Ventricular diastolic
LVD	Left Ventricular Dimension
LVDd	Left Ventricular Dimension Diastolic

## Abbreviations in User Interface (Continued)

<b>Abbreviation</b>	<b>Definition</b>
LVDFS	Left Ventricular Dimension Fractional Shortening
LVDs	Left Ventricular Dimension Systolic
LVEDV	Left Ventricular End Diastolic Volume
LVESV	Left Ventricular End Systolic Volume
LVET	Left Ventricular Ejection Time
LVO	Left Ventricular Opacification
LVOT	Left Ventricular Outflow Tract
LVOT Area	Left Ventricular Outflow Tract Area
LVOT D	Left Ventricular Outflow Tract Diameter
LVOT VTI	Left Ventricular Outflow Tract Velocity Time Integral
LVPW	Left Ventricular Posterior Wall
LVPWd	Left Ventricular Posterior Wall Diastolic
LVPWFT	Left Ventricular Posterior Wall Fractional Thickening
LVPWs	Left Ventricular Posterior Wall Systolic
LVs	Left Ventricular systolic
MB	SonoMB technology
MCA	Middle Cerebral Artery
MCCA	Mid Common Carotid Artery
MECA	Mid External Carotid Artery
MI	Mechanical Index
MICA	Mid Internal Carotid Artery
Mid	Middle
MM	M Mode
MR PISA	Mitral Regurgitation Proximal Iso Velocity Surface Area
MR/VTI	Mitral Regurgitation/Velocity Time Integral



## Abbreviations in User Interface (Continued)

<b>Abbreviation</b>	<b>Definition</b>
Msk	Musculoskeletal
MV	Mitral Valve
MV Area	Mitral Valve Area
MV Regurgitant Fraction	Mitral Valve Regurgitant Fraction
MV Regurgitant Volume	Mitral Valve Regurgitant Volume
MV/VTI	Mitral Valve/Velocity Time Integral
MVA	Mitral Valve Area
MV ERO	Mitral Valve Effective Regurgitant Orifice
MV PISA Area	Mitral Valve Proximal Iso Velocity Surface Area
MV Rate	Mitral Valve Rate
Neo	Neonatal
Nrv	Nerve
NST	Non-stress test
NTSC	National Television Standards Committee
OA	Ophthalmic Artery
OB	Obstetrical
OFD	Occipital Frontal Diameter
Oph	Ophthalmic
Orb	Orbital
PAL	Phase Alternating Line
PCAp	Posterior Cerebral Artery Peak
PCCA	Proximal Common Carotid Artery
PCoA	Posterior Communicating Artery
PECA	Proximal External Carotid Artery
PGmax	Maximum Pressure Gradient

## Abbreviations in User Interface (Continued)

<b>Abbreviation</b>	<b>Definition</b>
PGmean	Mean Pressure Gradient
PGr	Pressure Gradient
PHT	Pressure Half Time
PI	Pulsatility Index
PICA	Proximal Internal Carotid Artery
PISA	Proximal Isovelocity Surface Area
Plaq	Plaque
POST F	Posterior Far
POST N	Posterior Near
PRF	Pulse Repetition Frequency
Prox	Proximal
PSV	Peak Systolic Velocity
PV	Pulmonic Valve
P. Vein	Pulmonary Vein
PW	Pulsed Wave Doppler
Qp/Qs	Pulmonary blood flow divided by systemic blood flow
RA	Right Atrial (pressure)
RI	Resistive Index
RVD	Right Ventricular Dimension
RVDd	Right Ventricular Dimension Diastolic
RVDs	Right Ventricular Dimension Systolic
RVOT D	Right Ventricular Outflow Tract Diameter
RVOT VTI	Right Ventricular Outflow Tract Velocity Time Integral
RVSP	Right Ventricular Systolic Pressure
RVW	Right Ventricular Free Wall

## Abbreviations in User Interface (Continued)

<b>Abbreviation</b>	<b>Definition</b>
RVWd	Right Ventricular Free Wall Diastolic
RVWs	Right Ventricular Free Wall Systolic
S	SonoHD technology
S/D	Systolic/Diastolic Ratio
SI	Stroke Index
Siphon	Siphon (internal carotid artery)
SM	Submandibular
SmP	Small Parts
SO	Suboccipital
Sup	Superficial
SV	Stroke Volume
TAM	Time Average Mean
TAP	Time Average Peak
TCD	Trans-cerebellum Diameter (OB measurement) Transcranial Doppler (exam type)
TDI	Tissue Doppler Imaging
THI	Tissue Harmonic Imaging
TI	Thermal Index
TICA	Terminal Internal Carotid Artery
TO	Transorbital
TRmax	Tricuspid Regurgitation (peak velocity)
TT	Transtemporal
TTD	Transverse Trunk Diameter
TV	Tricuspid Valve
TVA	Tricuspid Valve Area

## Abbreviations in User Interface (Continued)

<b>Abbreviation</b>	<b>Definition</b>
UA	Ultrasound Age Calculated on the mean measurements taken for a particular fetal biometry.
Umb A	Umbilical Artery
VA	Vertebral Artery
VArty	Vertebral Artery
Vas	Vascular
Ven	Venous
VF	Volume Flow
Vmax	Peak Velocity
Vmean	Mean Velocity
Vol	Volume
VTI	Velocity Time Integral
YS	Yolk Sac

# Index

## Symbols

+/ $x$  measurement 50

## Numerics

2D imaging 25

2D options 25

## A

A & B shortcut keys 15

abbreviations 191

abdominal, intended uses 13

AC power indicator 6

acceleration (ACC) index 50

## accessories

compatible 106

accessories list 185

acoustic measurement precision 165

## acoustic output

measurement 121

tables 123, 164

acquisition error 172

add new user 16

Administrator 16

age, gestational 70

airborne equipment standards 187

ALARA principle 113, 114, 189

alphanumeric keys 5

angle correction 31, 32

## annotations

keys 5

place 39

predefine label groups 18

setup 18

aorta (Ao) 60

aortic valve area (AVA) 63

archivers 19

arrow graphic 40

ascending aorta (AAo) 60

audio 19

## B

bar code scanner 19

baseline 33

## battery

clean 86

safety 101

setup 19

specifications 186

beeps 19

biological safety 102

bodysmarker. *See* pictographs

brightness 26

## C

### cables

clean and disinfect ECG 86

connect power 3

### calculations

cardiac. *See* cardiac calculations

delete measurement 52

general 51

gynecology (Gyn) 66

IMT 67

menu 7, 51

OB 69

percent area 53

percent diameter 53

percent reductions 52

perform measurement 51

performing 51

repeat measurement 52

save 51

small parts 72

specialized 56

vascular 75

view measurement 52

- volume 54
- volume flow 54, 55
- calipers 47
- cardiac calculations
  - AAo 60
  - Ao 60
  - AVA 63
  - CI 64
  - CO 64
  - dP:dT 62
  - HR 64
  - IVRT 58
  - LA 60
  - LV volume (Simpson's Rule) 60
  - LVd 60
  - LVOT D 60
  - LVs 60
  - MV/AV area 60
  - overview 56
  - PHT 61
  - PISA 58
  - RVSP 61
  - setup 19
  - SV 63
  - TDI 65
  - VTI 61
- cardiac imaging applications 32
- cardiac index (CI) 64
- cardiac output (CO) 64
- cardiac references 173
- cardiac, intended uses 13
- cautions, definition 7
- cine buffer 5, 33
- clean
  - battery 86
  - ECG cable 86
  - footswitch 86
  - LCD screen 84
  - system 83
  - transducers 84
- clip acquisition delay 46
- clips
  - See also* images and clips
  - options 26, 42
- color Doppler (Color) imaging 30
- color power Doppler (CPD) imaging 30
- color scheme, background 22
- color suppress 30
- Color. *See* color Doppler (Color) imaging
- compatible
  - accessories 106
  - peripherals 106
- connectivity setup, wireless certificates 19
- continuous wave (CW) Doppler imaging 31, 32
- controls
  - direct 114
  - indirect 114
  - receiver 115
- CPD. *See* color power Doppler (CPD) imaging
- customer assistance 7
- CW Doppler. *See* continuous wave (CW) Doppler imaging
- D
- date 20
- default settings 15
- delta pressure:delta time (dP:dT) 62
- depth
  - adjust 33
  - definition 189
  - keys 5
  - marker 7
- DICOM 19
  - eFilm Lite 24
- DICOM standard 187
- disinfect
  - battery 86
  - ECG cable 86
  - system 83

- transducers 84
- disinfectants, compatibility 87
- display setup 20
- distance measurements
  - 2D 48
  - M mode 49
- D-line 31
- Doppler
  - Doppler gate depth 32
  - measurements 49
  - scale setup 22
- dual images 26
- duplex 22
- DVD recorder 19, 81
- Dynamic Range 22
- E
- ECG
  - Monitoring 26, 45
- eFilm Lite image-viewer 24
- elapsed time (ET) measurement 50
- electrical
  - safety 98
  - specifications 186
- electromagnetic compatibility 104
- electromechanical safety standards 186
- EMC classification standards 187
- EMED worksheets 79
- equipment safety 100
- error message 100
- errors
  - acquisition 172
  - algorithmic 172
  - measurement 172
- estimated date of delivery (EDD) 177
- estimated fetal weight (EFW) 178
- Event log 17
- exam
  - change type 34
  - end 41
  - type and transducer 35
- export and import
  - OB calculation tables 21
  - predefined label groups 18
  - user accounts 17
- F
- far 5
- fetal heart rate (FHR) 71
- flow sensitivity 31
- focal zones, optimize 25
- footswitch setup 15
- forms 6
- freeze 33
- G
- gain
  - adjust 33
  - ECG 46
  - knob 5
- gate size 32
- gestational age
  - setup 20
  - tables, references 178
- gestational growth, measure 71
- grace period 82
- grayscale 25
- growth analysis
  - setup 20
  - tables, references 180
- guidance documents, related 120
- guideline 26
- gynecology (Gyn)
  - calculations 66
  - intended uses 13
- H
- heart rate 41
- heart rate (HR) 49, 64, 71
- HIPAA standard 187
- home position 40
- humidity limits 186
- I
- image quality, poor 81

- images and clips
  - archive 45
  - delete 45
  - export to USB 45
  - review 44
- imaging modes
  - list of 185
  - transducer 35
- import. *See* export and import
- IMT. *See* Intima Media Thickness (IMT)
- in situ, definition 189
- include private tags, private tags 23
- infertility, intended uses 13
- intended uses 13–14
- intensity
  - derated 121
  - in situ 121
  - water-value 121
- interventional, intended uses 13
- Intima Media Thickness (IMT)
  - calculations 20, 67
  - sketch 69
  - trace 69
- intraoperative, intended uses 13
- invert
  - Color 31
  - spectral trace 33
- iso volumic relaxation time (IVRT) 58
- K
- keys 5
- knobs 5
- L
- labeling symbols 166
- language 22
- layout 22
- LCD screen
  - clean 84
  - output 119
- left atrium (LA) 60
- left ventricular diastolic (LVd) 60
- left ventricular outflow tract diameter (LVOT D) 60
- left ventricular systolic (LVs) 60
- left ventricular volume (LV volume) 60
- license key 82
- live trace 22, 33
- login
  - Administrator 16
  - user 16
- LVO (Left Ventricular Opacification) 26
- M
- M Mode imaging 30
- maintenance 82
- measurements
  - +x Ratio, Doppler 50
  - See also* calculations
  - 2D 48
  - about 47
  - Acceleration, Doppler 50
  - accuracy 47, 171
  - area, 2D 48
  - automatic trace, Doppler 50
  - circumference, 2D 48
  - delete 47
  - distance, 2D 48
  - distance, M Mode 49
  - Doppler 49
  - edit 47
  - Elapsed Time, Doppler 50
  - errors 172
  - fetal heart rate 71
  - heart rate 49, 71
  - M Mode 49
  - manual trace 48, 50
  - Pressure Gradient, Doppler 49
  - publications 173
  - Resistive Index, Doppler 50
  - save to calculation and report 47
  - terminology 173
  - vascular 75



- Velocities, Doppler 50
- mechanical index (MI) 119, 189
- mitral valve/aortic valve (MV/AV) 60
- M-line 30
- mode data 7, 20
- modes, keys 6
- MPPS 19
- N
- near 5
- network 20
- NTSC
  - definition 189
  - option 19
- O
- OB
  - calculations 20, 69
  - custom measurements setup 21
  - custom tables setup 21
  - graphs 78
  - intended uses 13
  - references 177
  - tables setup 22
- on-screen controls 6
- optimize 25
- Orbital calculations 73
- orientation
  - marker 7
  - option 26
- output display 119
- P
- PAL
  - definition 189
  - option 19
- password 16, 17, 18
- patient header 7, 20
- patient information form 40, 43, 44
- patient list 43
- patient report
  - about 77
  - cardiac 77
  - general 77
  - OB 78
  - save measurement to 47
  - vascular 77
- PC 19
- pediatric, intended uses 13
- percent reduction calculations 52
- peripherals 186
  - compatible 106
- pictographs
  - PICTO key 7
  - placing 40
- power delay 19
- power key 5
- precision, acoustic measurement 165
- preferences 22
- presets 22
- pressure half time (PHT) 61
- pressure limits 186
- PRF 31, 32
- print 44
- printer
  - problem 81
  - setup 19
- probe. *See* transducer
- proximal isovelocity surface area (PISA) 58
- pulsed wave (PW) Doppler imaging 31
- PW Doppler. *See* pulsed wave (PW) Doppler imaging
- R
- recording problem 81
- references
  - cardiac 173
  - general 182
  - gestational age tables 178
  - growth analysis tables 180
  - obstetrical 177
  - ratio calculations 181
- report, patient 77
- resistive index (RI) measurement 50

- right ventricular systolic pressure (RVSP) 61
- S
- safety
  - battery 101
  - biological 102
  - electrical 98
  - electromagnetic compatibility 104
  - equipment 100
- save
  - calculations 51
  - image 6
  - measurements 47
- SAVE key 22
- scale 32
- scanhead. *See* transducer
- screen layout 7
- security 15, 16
- separation distance 106
- serial port 19
- setup pages 15
- shipping specifications 186
- shortcut keys 15
- Simpson's Rule 60
- skin line, definition 190
- sleep delay 19
- small parts calculations 72
- software license 82
- SonoHD 190
- SonoMB 26, 190
- specifications 185
- spectral trace 32
- standards
  - acoustic 187
  - airborne equipment 187
  - DICOM 187
  - electromechanical 186
  - EMC classification 187
  - HIPAA 187
- steering
  - CPD 31
  - Doppler 32
- storage commitment 19
- storage specifications
  - equipment 186
  - images 185
- stroke volume (SV) 63
- superficial, intended uses 13
- sweep speed
  - Doppler 33
  - ECG 46
  - M Mode 30
- symbols, labeling 166
- system
  - clean and disinfect 83
  - controls 5
  - separate 2
  - software 1
  - status 7, 20
  - wake up 3
- T
- Technical Support 7
- temperature limits 186
- text 39
- text description 7
- thermal index (TI) 22, 119, 190
- THI 27
- time setup 20
- tissue Doppler imaging (TDI) 32, 65
- tissue models 122
- touchpad 6, 9
- Transcranial Doppler calculations 73
- transcranial, intended uses 14
- transducer
  - clean and disinfect 84
  - curved array 189
  - definition 190
  - disinfect 84
  - exam type 35
  - general use 11
  - imaging modes 35

- invasive or surgical use 11
- linear array 189
- preparation 11
- problems 81
- specifications 185

troubleshoot 81

U

- ultrasound terminology 189
- unfreeze text 18
- USB storage device, export to 45
- user account 17
- user guide, conventions used 7
- user setup 16
- uses, intended 13–14

V

- variance 31
- vascular
  - calculations 75
  - intended uses 14
- velocity measurement 50
- velocity time integral (VTI) 61
- volume
  - calculations 54
  - Doppler, adjust 33
- volume flow 54

W

- wall filter 31, 33
- warnings, definition 7
- worksheets, EMED 79

Z

- zoom 34







**SonoSite**  
**FUJIFILM**

P07662-04

